

TYPE B GAS VENT

Simpson Dura-Vent
Engineered Excellence

SIMPSON
Dura-Vent

Applications

Simpson Dura-Vent's Type B Gas Vent system. Use with natural gas or liquid propane category I and draft hood equipped appliances, and appliances tested and listed to use Type B Gas Vent. Applications include: natural gas fireplaces, gas-fired furnaces, boilers, water heaters, and wall or space heating applications.

Materials and Construction

Round Type B Gas Vent 3" - 8" and oval 4" - 6": Aluminum .012" inner wall, galvanized .018" outer wall.

Round Type B Gas Vent 10" - 16": Aluminum .016" inner wall, galvanized .021" outer wall.

Round Type B Gas Vent 18" - 30": aluminum .020" inner wall, galvanized .021" outer wall.

3"-16" diameters feature twist-lock fittings, screws required for 14" and larger diameters.

Clearances

1" clearance to combustibles in single and multi-family dwellings.

Diameters

3"- 30" Round Diameter.
4", 5", and 6" Oval

Listings

UL Listed to UL 441 and UL 1777 (MH6357).

ULC Listed to ULC S605 (CMH1276 & CMH1407).



UL 441 and ULC S605 System

Type B Gas Vent

Simpson Dura-Vent innovative system for a lock-tight connection for Type B Gas Vent called DuraLock. See the alignment indicators meet; feel the ends grasp together; hear the snap as the connection firmly locks into place. (See next page.)

Simpson Dura-Vent Type B Gas Vent is designed to meet the rugged demands of the job site. The inner wall is recessed to eliminate damage in handling.

Type B Gas Vent has been engineered to heat up rapidly. It remains hot during the operation of the appliance with minimal condensation in the appliance and vent system. Pipe lengths are available in multiple lengths, 6 to 60 inches, with a full complement of adjustable and rigid fittings.



Type B gas vents are not suitable for use with wood-burning or coal applications, industrial ovens, exhaust ranges and hoods, grease or pollution ducting, or as free-standing exhaust vents for high-temperature applications.

**An Innovative System for a Lock-Tight Connection for Type B Gas Vent. DuraLock.
See, Hear, and Feel the Difference....**

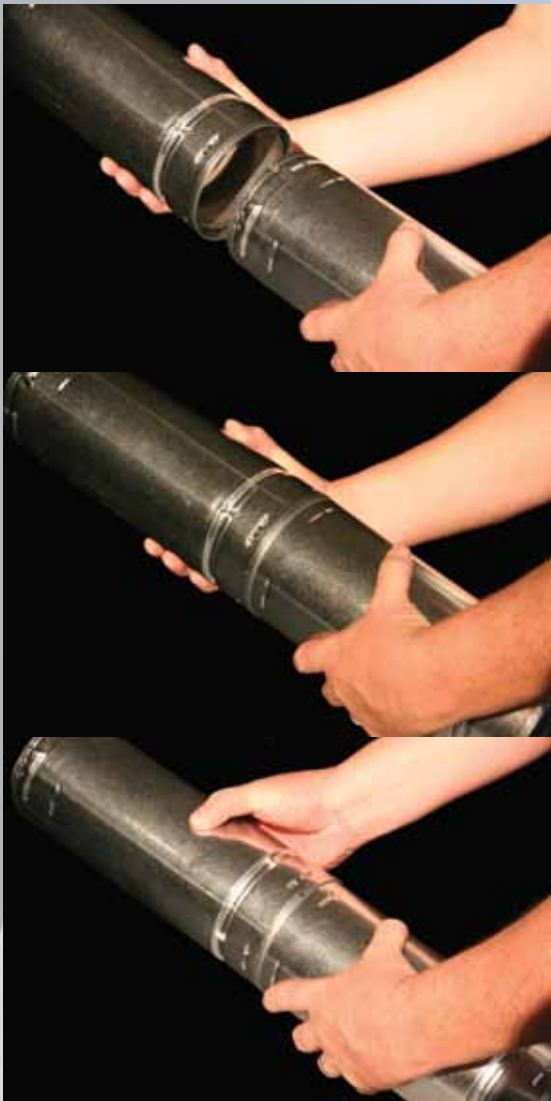

An innovative system for a lock-tight connection that you see, feel, and hear... assuring a snug fit every time.

See...the alignment indicators meet when connection locks into place.
Feel...the ends grasp together as sections twist into their locked position.
Hear...the snap as the connection firmly locks into place.

With DuraLock, there is no need to find sharp tabs to bend into slots. DuraLock is a sleek design without perforations to minimize heat loss.

DuraLock is a welcome solution to installations. No sheet metal screws are needed. No tools are required. Installation time is minimized.

Even with a firm lock, the DuraLock system still allows the installer to unlock the pipe to change lengths, if needed. No tools are required to bend or to pry the lock apart.

DuraLock is compatible with existing inventories of Simpson DuraVent Type B Gas Vent. Patent pending.



DuraConnect II

Materials and Construction

.010" Double-wall aluminum flex inner wall (two-ply .005"), .018" galvalume outer wall, with twist-lock connections.

Clearances 1" to combustibles.

Diameters 3", 4", 5", and 6".

Listings

c-UL-us Listed to UL 441 and ULC/ORD-C441 (MH14089).



DuraConnect I

Materials and Construction

.010" Single-wall aluminum flex (two-ply .005"), with twist-lock connections.

.018" Single-wall galvalume components with twist-lock connections.

Clearances 1" to combustibles.

Diameters 3", 4", 5", and 6".

Patented

Listings

c-UL-us 441 and ULC/ORD C441 (MH14089).



c-UL-us 441 System

DuraConnect II

Double-wall connector pipe, UL approved as a Type B Gas Vent segment, for use in conditioned and unconditioned attics and crawl spaces. (Not to be enclosed and cannot penetrate through walls, floors, or ceilings.) Simpson Dura-Vent's DuraConnect II is known as the "Contractor's Choice" for its ease of installation and durability.

DuraConnect II's heavy-duty construction features precision twist-lock connection, which provides ease of assembly or disassembly without damage to the product.

The double-wall flexible vent is certified as having the equivalent thermal properties as Type B Gas Vent and can be used when a Type B Gas Vent double-wall connector is required.

DuraConnect I

Single-wall connector pipe and components for use wherever single-wall connectors are allowed.

It offers a quick, easy connection from an appliance to the B-Vent system. Its flexible connector pipe can flex to make offsets connect directly to Simpson Dura-Vent's Type B Gas Vent, without the use of elbows.

Typical Installations

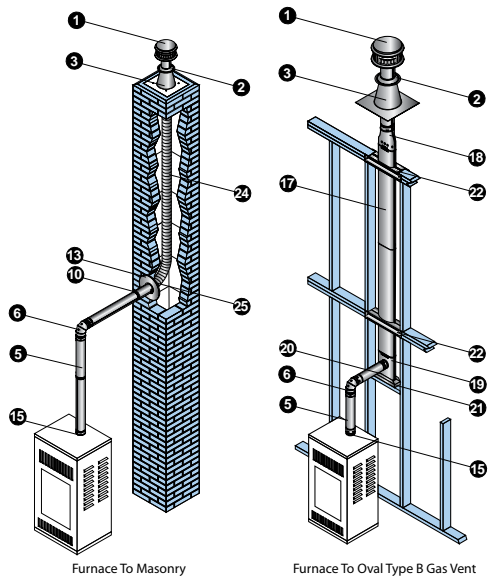

Furnace To Masonry

Furnace To Oval Type B Gas Vent

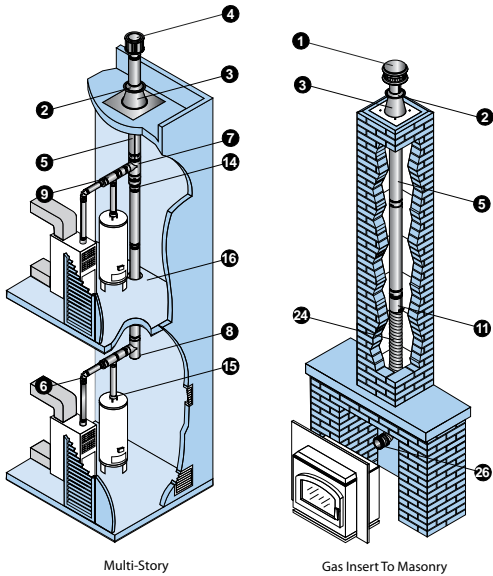

Multi-Story

Gas Insert To Masonry

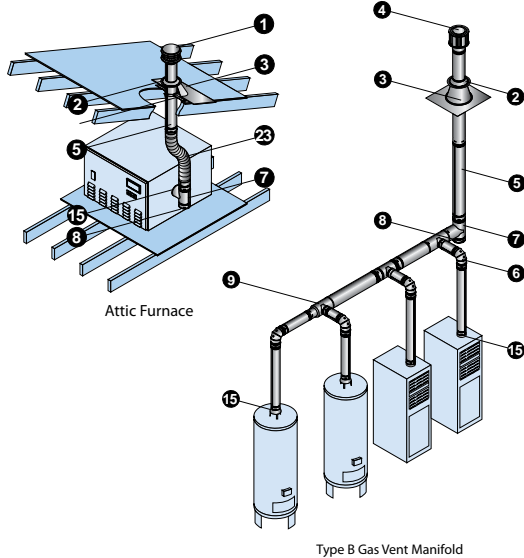

Attic Furnace

Type B Gas Vent Manifold

Installation Key			
1	DuraCap	14	Increaser
2	Storm Collar	15	Draft Hood Connector
3	Roof Flashing	16	Square Firestop Support
4	High-Wind Cap	17	Oval Pipe
5	Round Pipe	18	Oval to Round Adapter
6	Elbow	19	Oval Tee
7	Tee	20	Oval Tee Cap
8	Tee Cap	21	Oval Tee Support
9	Increaser Tee	22	Oval Firestop Spacer
10	Female Flex Adapter	23	DuraConnect II
11	Male Adapter	24	DuraFlex AL Length
12	Double-Wall Wye	25	DuraFlex Motar Sleeve
13	Pipe Collar	26	DuraFlex AL Coupling

Refer to our Typical Venting Installation drawings to select the appropriate component parts for your installation.

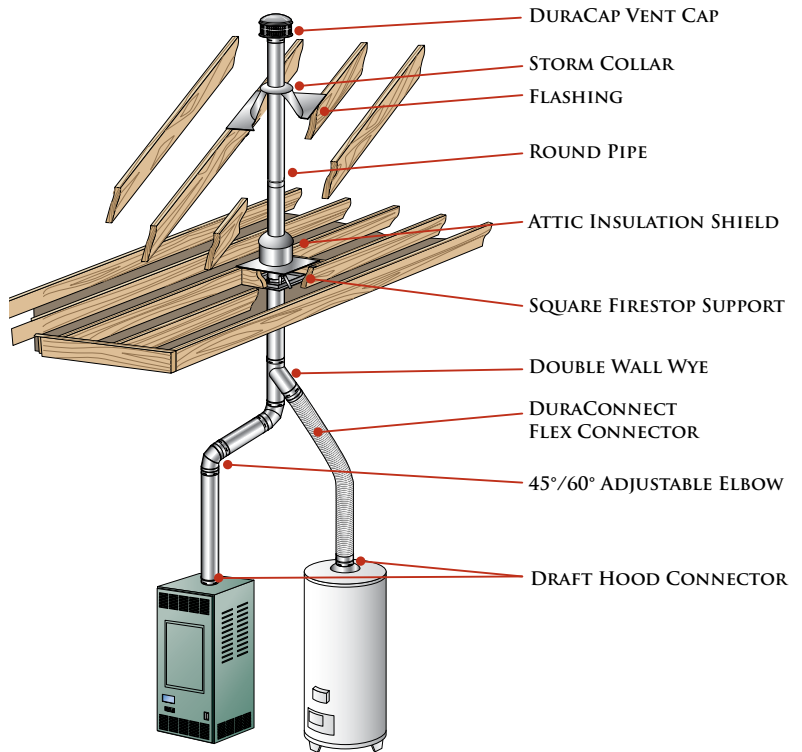

How Size and Height Affect Stove Performance

- The amount of heat the vent gases lose as they flow determines how much condensation will occur and how strong the draft will be. To control the heat losses, proper selection of venting materials is of vital importance.
- Double-wall Type B Gas Vent, with an aluminum inner wall and a galvanized steel outer wall, has proven to be the ideal choice in venting materials.
- A Type B Gas Vent Sizing Handbook is available to assist you with the proper installation. View online at www.duravent.com, under catalogs and instructions.

Vent Termination Chart

Using listed Type B Gas Vent caps may terminate in accordance with this table.

Roof Pitch	Minimum Height	
	Feet	Meters
Flat to 7/12	1	0.30
Over 7/12 to 8/12	1.5	0.46
Over 8/12 to 9/12	2	0.61
Over 9/12 to 10/12	2.5	0.76
Over 10/12 to 11/12	3.25	0.99
Over 11/12 to 12/12	4	1.22
Over 12/12 to 14/12	5	1.52
Over 14/12 to 16/12	6	1.83
Over 16/12 to 18/12	7	2.13
Over 18/12 to 20/12	7.5	2.29
Over 20/12 to 21/12	8	2.44

Gas Vent Specification Chart

Item	Clearances	Maximum Height	Outer Tube Ø	Materials	Locking Device	UL Listing	ULC Listing
Type B Vent Round 3"-8"	1 inch to combustibles	100 feet	5/8" larger than ID	Inner - .012" Aluminum Outer - .018" Galvanized	DuraLock	MH6357	CMH1276
Round 10" to 16" See note 2	1 inch to combustibles	100 feet	1" larger than ID	Inner - .016" Aluminum Outer - .021" Galvanized	TwistLock Screws	MH6357	CMH1276
Round 18" to 30"	1 inch to combustibles	100 feet	2" larger than ID See note 5	Inner - .020" Aluminum Outer - .021" Galvanized	Screws	MH6357	CMH1276
Oval Type B Vent 4" and 5"	2" x 4" & 2" x 6" stud wall and 1 inch to combustibles	See Note 3	2 1/2" x 7 1/4" 3 1/8" x 10 7/8"	Inner - .012" Aluminum Outer - .018" Galvanized	Button Lock	MH6357	CMH1276
Oval Type B Vent 6"	2" x 6" stud wall and 1 inch to combustibles	See Note 3	3 1/4" x 12"	Inner - .012" Aluminum Outer - .018" Galvanized	Button Lock	MH6357	CMH1276
Type B Vent 3" to 6" Round Liner	0"/Masonry	50 feet	5/8" larger than ID	Inner - .012" Aluminum Outer - .018" Galvanized	DuraLock	MH14420 MH6357	CMH1407
DuraFlex AL Gas Relining 3" to 6"	0"/Masonry	50 feet	1/4" larger than ID	.010" Aluminum Flex	Screws DuraLock	MH14420	--
DuraConnect 3" to 6"	1 inch to combustibles	See Note 4	1/4" larger than ID	.010" Aluminum Flex .018" Galvalume	DuraLock	MH14089	--
DuraConnect II 3" to 6"	1 inch to combustibles	See Note 4	1/4" larger than ID	.010" Aluminum Flex .018" Galvalume	DuraLock	MH14089	--

NOTES
1. Clearance to combustibles is the air space between vent and combustibles.
2. Maximum height varies with equipment over 50', for taller applications refer to SDV sizing handbook (L202). 14"-16" Pipe require screws.
3. When oval is used on wall furnaces, minimum height required from bottom of furnace to cap is 12', minimum 16" stud space.
4. Limited by sizing tables.
5. 18" pipe OD is one inch larger than ID and 20" - 30" OD is 2" greater than ID.

ROUND TYPE B GAS VENT

Round Rigid Pipe

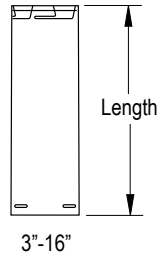

Use for venting listed natural gas or liquid propane Category I, draft hood appliances, or appliances that have been specifically tested and listed to use Type B Gas Vent. The appliances listed typically use Type B Gas Vent systems, but not always: Furnaces, Water Heaters, Boilers, Room Heaters, Decorative Gas Appliances, and Unit Heaters.

To calculate installed length, subtract 1 1/2" from each connection of vent. A 1" clearance (air space) to combustibles must be maintained. To calculate OD add 5/8".

Type B Gas Vent systems may be used on other gas-burning appliances, when specified by appliance manufacturer. Type B Gas Vent is not used for Category II, III, or IV gas appliances, unless specified by appliance manufacturer.

SIZE	LENGTH	ORDER #	STOCK #	SIZE	LENGTH	ORDER #	STOCK #
3"	6"	3GV06	40	6"	6"	6GV06	43
3"	12"	3GV12	30	6"	12"	6GV12	33
3"	18"	3GV18	20	6"	18"	6GV18	23
3"	24"	3GV24	385	6"	24"	6GV24	388
3"	36"	3GV36	10	6"	36"	6GV36	13
3"	48"	3GV48	400	6"	48"	6GV48	403
3"	60"	3GV60	1	6"	60"	6GV60	4
4"	6"	4GV06	41	7"	6"	7GV06	44
4"	12"	4GV12	31	7"	12"	7GV12	34
4"	18"	4GV18	21	7"	18"	7GV18	24
4"	24"	4GV24	386	7"	24"	7GV24	389
4"	36"	4GV36	11	7"	36"	7GV36	14
4"	48"	4GV48	401	7"	48"	7GV48	404
4"	60"	4GV60	2	7"	60"	7GV60	5
5"	6"	5GV06	42	8"	12"	8GV12	35
5"	12"	5GV12	32	8"	18"	8GV18	25
5"	18"	5GV18	22	8"	24"	8GV24	390
5"	24"	5GV24	387	8"	36"	8GV36	15
5"	36"	5GV36	12	8"	48"	8GV48	405
5"	48"	5GV48	402	8"	60"	8GV60	6
5"	60"	5GV60	3				

Large Diameter Round Rigid Pipe

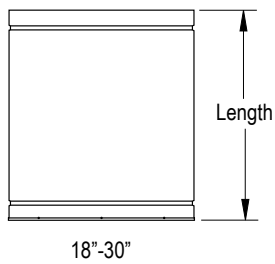
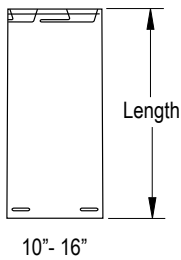

To calculate installed length, subtract 1 1/2" (for 10"-16" diameter) and 1 1/8" (for 18"-30" diameter) from each connection of vent. A 1" clearance (air space) to combustibles materials must be maintained. 18"-30" diameters are built to order and are not returnable.

SIZE	LENGTH	ORDER #	STOCK #	O.D.
10"	18"	10GV18	2426	11"
10"	36"	10GV36	2516	11"
12"	18"	12GV18	2427	13"
12"	36"	12GV36	2517	13"
14"	18"	14GV18	2520	15"
14"	36"	14GV36	2500	15"
16"	18"	16GV18	2521	17"
16"	36"	16GV36	2501	17"
18"	18"	18GV18	2522	20"
18"	36"	18GV36	2502	20"
20"	18"	20GV18	2523	22"
20"	36"	20GV36	2503	22"
22"	18"	22GV18	2524	24"
22"	36"	22GV36	2504	24"
24"	18"	24GV18	2525	26"
24"	36"	24GV36	2505	26"
26"	18"	26GV18	2526	28"
26"	36"	26GV36	2506	28"
28"	18"	28GV18	2527	30"
28"	36"	28GV36	2507	30"
30"	18"	30GV18	2528	32"
30"	36"	30GV36	2508	32"

Flex Pipe

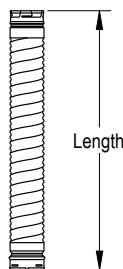

Use for offsets when relining a masonry chimney with Simpson Dura-Vent Type B Gas Vent. Add 5/8" for OD.

SIZE	LENGTH	ORDER #	STOCK #
4"	5'	4GV60F	2F
5"	5'	5GV60F	3F
6"	5'	6GV60F	4F

Round Adjustable Pipe

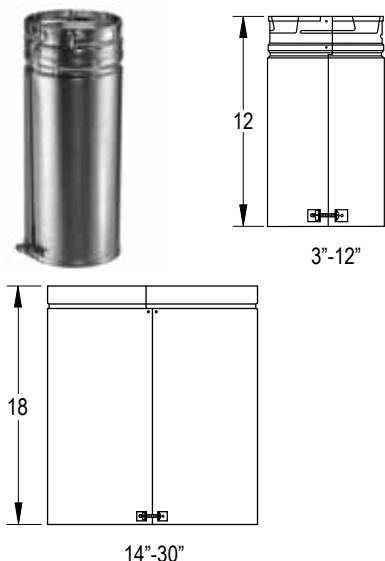

Use to add length to a straight length of Type B Gas Vent. 12" adds 3"-10" of length, 18" adds 10"-16" of length. Requires a 2" overlap.

SIZE	LENGTH	ORDER #	STOCK #	SIZE	LENGTH	ORDER #	STOCK #
3"	3" - 10"	3GV12A	50	16"	10" - 16"	16GV18A	2671
4"	3" - 10"	4GV12A	51	18"	10" - 16"	18GV18A	2672
5"	3" - 10"	5GV12A	52	20"	10" - 16"	20GV18A	2673
6"	3" - 10"	6GV12A	53	22"	10" - 16"	22GV18A	2674
7"	3" - 10"	7GV12A	54	24"	10" - 16"	24GV18A	2675
8"	3" - 10"	8GV12A	55	26"	10" - 16"	26GV18A	2676
10"	3" - 10"	10GV12A	2456	28"	10" - 16"	28GV18A	2677
12"	3" - 10"	12GV12A	2457	30"	10" - 16"	30GV18A	2678
14"	10" - 16"	14GV18A	2670				

90° Adjustable Elbow

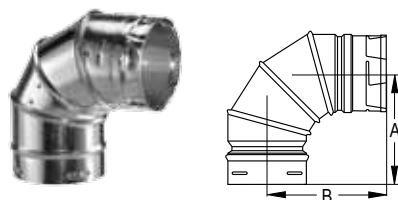

Offsets obstructions as needed. Elbows (3"-8") swivel 360° at base. 90° Elbow is adjustable from 0° to 90° in sizes 3"-10". Elbows must be supported when installed.

SIZE	ORDER #	STOCK #	A	B
3"	3GVL90	60	5 1/2"	5 1/4"
4"	4GVL90	61	6"	5 1/2"
5"	5GVL90	62	6 1/2"	6 1/2"
6"	6GVL90	63	6 3/4"	6 3/4"
7"	7GVL90	64	7 3/4"	7 1/2"
8"	8GVL90	65	7 3/4"	7 1/2"
10"	10GVL90	2466	10 1/4"	9 5/8"

45°/60° Adjustable Elbow

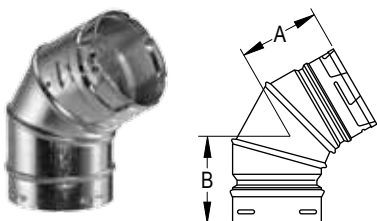

Offsets obstructions as needed. Elbows swivel 360° at base. 45°/60° Elbow is adjustable from 0° to 60°. Elbows must be supported when installed.

SIZE	ORDER #	STOCK #	A	B
3"	3GVL45	70	4"	4"
4"	4GVL45	71	4 1/2"	4 1/2"
5"	5GVL45	72	4 1/2"	4 1/2"
6"	6GVL45	73	5"	5"

45° Elbow

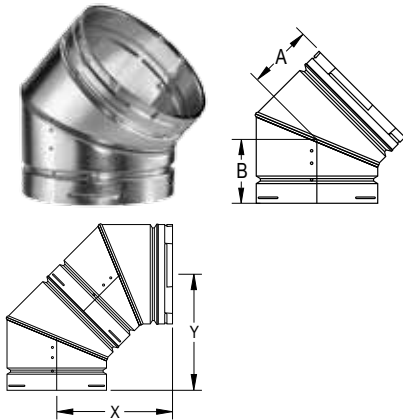

90° offset using two 45° Elbows

Offsets obstructions as needed. 45° Elbow in size 7"-30". Elbows up to 12" are adjustable. Sizes 14" and larger are not adjustable. Elbows must be supported when installed.

SIZE	ORDER #	STOCK #	A	B	X	Y
7"	7GVL45	74	4 3/4"	4 3/4"	10 1/2"	10 1/2"
8"	8GVL45	75	4 3/4"	4 3/4"	10 1/4"	10 1/4"
10"	10GVL45	2476	5 1/2"	5 3/4"	--	--
12"	12GVL45	2477	6 1/8"	6 1/4"	13 7/8"	14"
14"	14GVL45	2550	6 1/2"	6 7/8"	14 7/8"	15 1/4"
16"	16GVL45	2551	7 1/4"	7 3/8"	16 1/2"	16 1/2"
18"	18GVL45	2552	9"	8 1/2"	20 1/8"	21 7/8"
20"	20GVL45	2553	9"	8 3/8"	20 1/4"	21 3/4"
22"	22GVL45	2554	8 1/2"	9 3/4"	20 3/8"	21 5/8"
24"	24GVL45	2555	9 1/2"	9 3/4"	21"	21 7/8"
26"	26GVL45	2556	10 1/4"	10 1/4"	21 1/2"	22 3/4"
28"	28GVL45	2557	9 3/4"	10"	21 1/2"	22 3/4"
30"	30GVL45	2558	9 3/4"	10"	23 3/4"	24"

Standard Tee

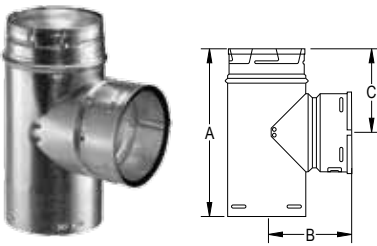

Use for a 90° offset or to combine connectors from two or more appliances into a common vent. Branch swivels for alignment. 3"-8" feature swivel on male end.

SIZE	ORDER #	STOCK #	A	B	C
3"	3GVT	80	9"	4 1/2"	4 1/4"
4"	4GVT	81	9 7/8"	4 3/4"	4 3/4"
5"	5GVT	82	11"	5 1/2"	5 1/4"
6"	6GVT	83	12"	5 3/4"	5 5/8"
7"	7GVT	84	13"	6 5/16"	6 1/4"
8"	8GVT	85	14"	7 3/8"	7"
10"	10GVT	2586	17 1/2"	8 1/2"	8 3/4"
12"	12GVT	2587	19 3/4"	10"	9 3/8"
14"	14GVT	2540	20 7/8"	11"	10 1/2"
16"	16GVT	2541	24 1/2"	12 1/4"	12 1/4"
18"	18GVT	2542	29"	15"	15"
20"	20GVT	2543	32"	16"	16"
22"	22GVT	2544	33"	17"	17"
24"	24GVT	2545	35"	18"	18"
26"	26GVT	2546	35 1/2"	18 1/2"	17 3/4"
28"	28GVT	2547	36"	19"	18 1/2"
30"	30GVT	2548	41 1/2"	20 1/2"	20 3/4"

Increaser Tee

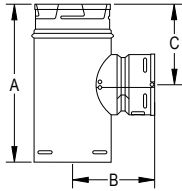

Attaches smaller pipe to branch and larger pipe to body. Use for a 90° offset or to combine connectors from two or more appliances into a common vent. Branch swivels for alignment. Swivel on male end. Additional sizes available through special order.

SIZE	ORDER #	STOCK #	A	B	C
4" x 3"	4GVTR3	81T3	9"	4 13/16"	4 3/8"
5" x 4"	5GVTR4	82T4	9 3/4"	5 1/2"	4 3/4"
5" x 3"	5GVTR3	82T3	8 7/8"	5 1/2"	4"
6" x 4"	6GVTR4	83T4	9 3/4"	6"	5 1/2"
6" x 3"	6GVTR3	83T3	8 3/4"	6"	4"

Tee Cap



Use to cap Standard Tee or Increaser Tee. Remove Tee Cap to inspect the system; clean out debris or collected condensate from the common vent. Fits on inner liner.

SIZE	ORDER #	STOCK #
3"	3GVTC	90
4"	4GVTC	91
5"	5GVTC	92
6"	6GVTC	93
7"	7GVTC	94
8"	8GVTC	95
10"	10GVTC	2596
12"	12GVTC	2597
14"	14GVTC	2690
16"	16GVTC	2691
18"	18GVTC	2692
20"	20GVTC	2693
22"	22GVTC	2694
24"	24GVTC	2695
26"	26GVTC	2696
28"	28GVTC	2697
30"	30GVTC	2698

Double-Wall Wye - 45° Branch

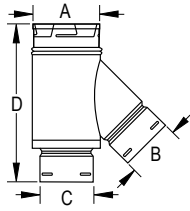

Use to combine connectors from two or more appliances into a common vent. Branch swivels for alignment. Swivel on male end. Additional sizes available through special order.

SIZE	ORDER #	STOCK #	A	B	C	D
4" x 4" x 3"	4GVY43	425	4 5/8"	4 5/8"	3 5/8"	13 7/8"
4" x 4" x 4"	4GVY44	426	4 5/8"	4 5/8"	4 5/8"	13 7/8"
4" x 3" x 4"	4GVY34	427	4 5/8"	3 5/8"	4 5/8"	10 3/4"
5" x 3" x 4"	5GVY34	430	5 5/8"	3 5/8"	4 5/8"	12 1/4"
5" x 4" x 4"	5GVY44	431	5 5/8"	4 5/8"	4 5/8"	14"
5" x 4" x 5"	5GVY45	432	5 5/8"	4 5/8"	5 5/8"	12"
6" x 3" x 4"	6GVY34	440	6 5/8"	3 5/8"	4 5/8"	12 5/8"
6" x 4" x 3"	6GVY43	441	6 5/8"	4 5/8"	3 5/8"	13 1/2"
6" x 4" x 4"	6GVY44	442	6 5/8"	4 5/8"	4 5/8"	14"
6" x 4" x 5"	6GVY45	443	6 5/8"	4 5/8"	5 5/8"	13 1/4"
6" x 3" x 5"	6GVY35	445	6 5/8"	3 5/8"	5 5/8"	13 1/4"
6" x 4" x 6"	6GVY46	446	6 5/8"	4 5/8"	6 5/8"	12"
7" x 3" x 5"	7GVY35	450	7 5/8"	3 5/8"	5 5/8"	12 1/4"

Draft Hood Connector

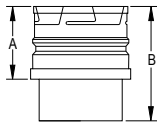

Use to connect appliance or single-wall connector to vent system.

SIZE	ORDER #	STOCK #	A	B
3"	3GVC	120	3"	6"
4"	4GVC	121	3"	6"
5"	5GVC	122	3"	6"
6"	6GVC	123	3"	6"
7"	7GVC	124	3"	6"
8"	8GVC	125	3"	6"
10"	10GVC	2626	4"	7 3/8"
12"	12GVC	2627	4"	7 3/8"
14"	14GVC	2590	6"	10"
16"	16GVC	2591	5 3/4"	10"
18"	18GVC	2592	6"	12"
20"	20GVC	2593	6"	12"
22"	22GVC	2594	6"	14 3/4"
24"	24GVC	2595	6"	14"

Increaser

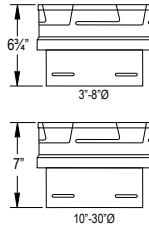

Use to increase vent diameter. Additional sizes available through special order. **Specified diameter (i.e.: 6GVX10).

SIZE	ORDER #	STOCK #	SIZE	ORDER #	STOCK #
3" x 4"	3GVX4	1005	7" x 8"	7GVX8	1085
3" x 5"	3GVX5	1015	** x 10"	**GVX10	2409
3" x 6"	3GVX6	1025	** x 12"	**GVX12	2511
3" x 7"	3GVX7	1125	** x 14"	**GVX14	2509
4" x 5"	4GVX5	1035	** x 16"	**GVX16	2519
4" x 6"	4GVX6	1045	** x 18"	**GVX18	2529
4" x 7"	4GVX7	1135	** x 20"	**GVX20	2539
4" x 8"	4GVX8	1165	** x 22"	**GVX22	2549
5" x 6"	5GVX6	1055	** x 24"	**GVX24	2559
5" x 7"	5GVX7	1155	** x 26"	**GVX26	2569
5" x 8"	5GVX8	1175	** x 28"	**GVX28	2579
6" x 7"	6GVX7	1065	** x 30"	**GVX30	2589
6" x 8"	6GVX8	1075			

R/R Double-Wall Adapter

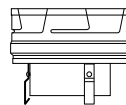

Clips snugly to plastic blower housing with stainless steel clips making installation a snap. Simply twist-lock male end and quickly install Simpson Dura-Vent Type B Gas Vent or DuraConnect to complete your installation. UL approved.

SIZE	ORDER #	STOCK #
3"	3GVRS	186C
3" - 4"	4GVRS	187C
3" - 5"	5GVRS	188C
4"	6GVRS	177C
4" - 5"	7GVRS	178C

Female Adapter

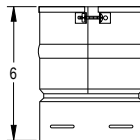

Use to connect listed Type B Gas Vent system manufactured by other companies to existing Simpson Dura-Vent Type B Gas Vent. For adapting to flex see DuraFlex Female Flex Adapter.

SIZE	ORDER #	STOCK #
3"	3GVAF	496
4"	4GVAF	497
5"	5GVAF	498
6"	6GVAF	499
7"	7GVAF	488
8"	8GVAF	495

Male Adapter

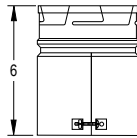

Use to connect existing Simpson Dura-Vent Type B Gas Vent to a listed Type B Gas Vent system manufactured by other companies. Male adapter can also be used to attach to DuraFlex AL.

SIZE	ORDER #	STOCK #
3"	3GVAM	490
4"	4GVAM	491
5"	5GVAM	492
6"	6GVAM	493
7"	7GVAM	487
8"	8GVAM	494

H/C Adapter

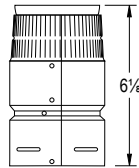

Use to connect Simpson Dura-Vent Type B Gas Vent products to an existing listed Type B Gas Vent system, manufactured by other companies using locking ring system.

SIZE	ORDER #
3"	496H
4"	497H
5"	498H
6"	499H

Wall Strap

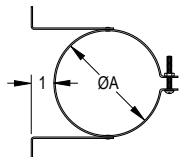

Use to provide support for offsets and horizontal runs. Recommended every 4' to support vertical common vent. Use also with DuraConnect or DuraConnect II. 10" Type B gas vent (11" OD) uses a 7" DuraPlus Chimney Wall Strap. Wall Strap legs can be rotated 360° to conceal screw.

SIZE	ORDER #	STOCK #	A
3"	3GVWS	1485	3 5/8"
4"	4GVWS	1486	4 5/8"
5"	5GVWS	1487	5 5/8"
6"	6GVWS	1488	6 5/8"
7"	7GVWS	1489	7 5/8"
8"	8GVWS	1490	8 5/8"
10"	--	9168	10 5/8"

Square Firestop Support

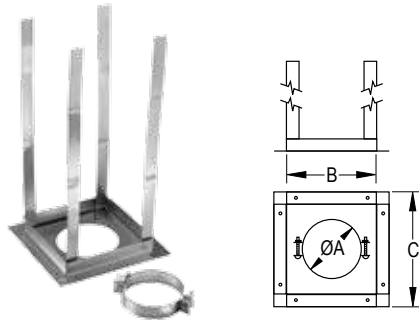

Use to support vent at ceiling level. Includes clamp that supports and prevents pipe sections from slipping down. Provides the mandatory 1" clearance to combustibles. Straps extend 16".

SIZE	ORDER #	STOCK #	A	B	C
3"	3GVRS	1440	3 3/4"	5 3/4"	7 3/4"
4"	4GVRS	1441	4 3/4"	6 3/4"	8 3/4"
5"	5GVRS	1442	5 3/4"	7 3/4"	9 3/4"
6"	6GVRS	1443	6 3/4"	8 3/4"	10 3/4"
7"	7GVRS	1444	7 3/4"	9 3/4"	11 3/4"
8"	8GVRS	1445	8 3/4"	10 3/4"	12 3/4"
10"	10GVRS	2620	10 3/4"	12 3/4"	14 3/4"
12"	12GVRS	2622N	12 3/4"	14 3/4"	16 3/4"

Gas Vent Roof Support

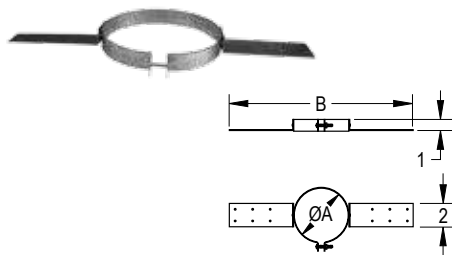

Use to support Type B gas vent pipe at roof level. Can be used when DuraConnect II is installed in attic space.

SIZE	ORDER #	STOCK #	A	B
3"	3GVS	1470	3 5/8"	14 3/4"
4"	4GVS	1471	4 5/8"	15 3/4"
5"	5GVS	1472	5 5/8"	16 3/4"
6"	6GVS	1473	6 5/8"	17 3/4"

Firestop Spacer

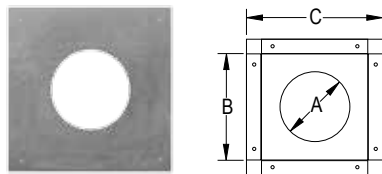

Use at every ceiling level where Square Firestop Support is not used. 3"-6" style may vary.

SIZE	ORDER #	STOCK #	A	B	C
3"	3GVFS	1460N	3 3/4"	5 3/4"	7 3/4"
4"	4GVFS	1461N	4 3/4"	6 3/4"	8 3/4"
5"	5GVFS	1462N	5 3/4"	7 3/4"	9 3/4"
6"	6GVFS	1463N	6 3/4"	8 3/4"	10 3/4"
7"	7GVFS	1464N	7 3/4"	9 3/4"	11 3/4"
8"	8GVFS	1465N	8 3/4"	10 3/4"	12 3/4"
10"	10GVFS	2621N	10 3/4"	12 3/4"	14 3/4"
12"	12GVFS	2623	12 3/4"	14 3/4"	16 3/4"

Round Bucket Support

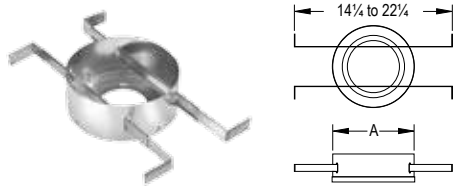

Use to support the Type B gas vent between 16" to 24" on-center joists or rafters. Use with a Draft Hood Connector to transition fitting between single-wall connector and Type B gas vent pipe sections. A Firestop Spacer is required.

SIZE	ORDER #	STOCK #	A
3" - 4"	3GVR54	340	7"
5" - 6"	3GVR55	342	8"
7" - 8"	3GVR56	344	10"

Pipe Collar

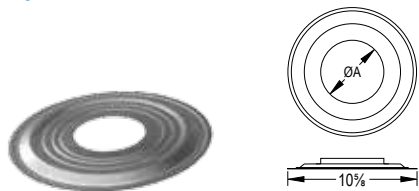

Use for decorative purposes. Optional.

SIZE	ORDER #	STOCK #	A
3"	3GVPC	170	3 3/4"
4"	4GVPC	171	4 3/4"
5"	5GVPC	172	5 3/4"
6"	6GVPC	173	6 3/4"

Wall Thimble

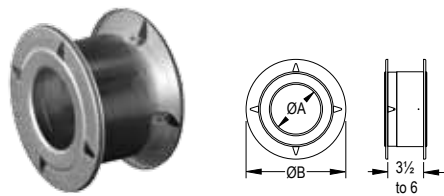

Use for through-the-wall system to provide clearances for vent from combustibles. Adjusts from 3 1/2" to 6" to accommodate various wall thicknesses. Larger diameter wall thimbles are field-fabricated. (See local codes for guidelines.)

SIZE	ORDER #	STOCK #	A	B
3"	3GVWT	160	3 3/4"	7 1/2"
4"	4GVWT	161	4 3/4"	8 1/2"
5"	5GVWT	162	5 3/4"	9 1/2"
6"	6GVWT	163	6 3/4"	10 1/2"
7"	7GVWT	164	7 3/4"	11 1/2"
8"	8GVWT	165	8 3/4"	12 1/2"

Attic Insulation Shield

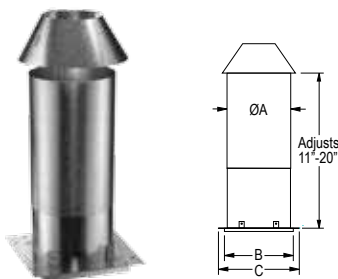

Required for installations that pass through an attic to prevent insulation and debris from accumulating near the vent.

SIZE	STOCK #	A	B	C
3" - 4"	354	6 3/4"	7 3/16"	9 1/4"
5" - 6"	355	8 3/4"	8 15/16"	11"
7" - 8"	356	10 3/4"	10 5/16"	13"

Storm Collar

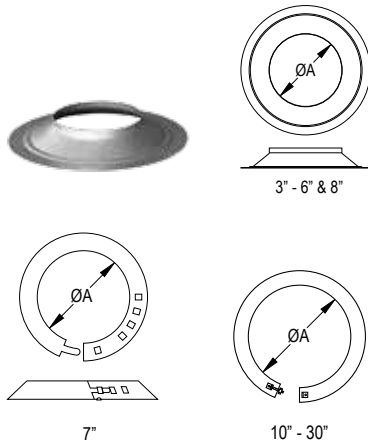

Use to maintain a weather tight resistant seal between the pipe and the flashing.

SIZE	ORDER #	STOCK #	A	SIZE	ORDER #	STOCK #	A
3"	3GVSC	150	3 3/8"	16"	16GVSC	2571	18"
4"	4GVSC	151	4 5/8"	18"	18GVSC	2572	20"
5"	5GVSC	152	5 5/8"	20"	20GVSC	2573	22"
6"	6GVSC	153	6 5/8"	22"	22GVSC	2574	24"
7"	7GVSC	154	7 5/8"	24"	24GVSC	2575	26"
8"	8GVSC	155	8 5/8"	26"	26GVSC	2576	28"
10"	10GVSC	2656	11"	28"	28GVSC	2577	30"
12"	12GVSC	2657	13"	30"	30GVSC	2578	32"
14"	14GVSC	2570	16"				

Adjustable Roof Flashing

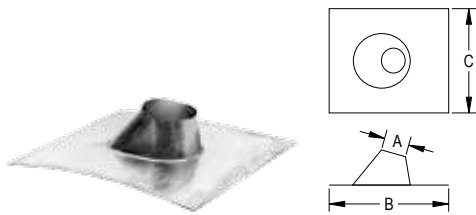

Use to weather proof the penetration of vent pipe through the roof. Storm Collar required. Select roof flashing based on pitch of roof. For pitches of 0/12 - 6/12. Made of galvalume.

SIZE	ORDER #	STOCK #	A	B	C
3"	3GVF	140	3 5/8"	18 3/8"	16"
4"	4GVF	141	4 5/8"	18 3/8"	17"
5"	5GVF	142	5 5/8"	20"	18 3/8"
6"	6GVF	143	6 3/4"	21 1/2"	19 1/4"
7"	7GVF	144	7 3/4"	22 1/2"	21 1/2"
8"	8GVF	145	8 3/4"	23 1/2"	21 1/2"
10"	10GVF	2646	11 3/8"	24"	24"
12"	12GVF	2647	13 1/2"	24"	24"
14"	14GVF	2580	15"	31 1/2"	29 1/2"
16"	16GVF	2581	17"	36"	33 1/2"
18"	18GVF	2582	20"	43"	40"
20"	20GVF	2583	22"	43"	40"
22"	22GVF	2584	24"	45"	41 1/2"
24"	24GVF	2585	26"	45"	44 3/4"
26"	26GVF	2686	28"	44 3/4"	44 3/4"
28"	28GVF	2687	30"	50"	50"
30"	30GVF	2688	32"	52"	52"

Steep Roof Flashing

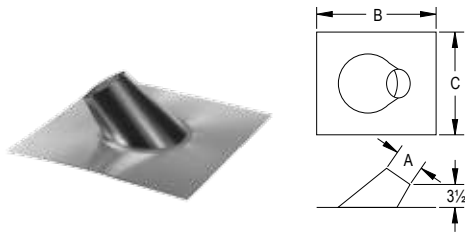

Use to weather proof the penetration of vent pipe through the roof. Storm Collar required. Select roof flashing based on pitch of roof. For pitches of 7/12 - 12/12. Made of galvalume.

SIZE	ORDER #	STOCK #	A	B	C
3"	3GVFSR	140S	3 3/4"	16"	18"
4"	4GVFSR	141S	4 3/4"	17"	20"
5"	5GVFSR	142S	5 3/4"	18"	21 3/4"
6"	6GVFSR	143S	6 3/4"	19 1/2"	23 3/4"
7"	7GVFSR	144S	7 3/4"	20 1/2"	24"
8"	8GVFSR	145S	8 3/4"	21"	25 1/2"

Tall Cone Flat Flashing

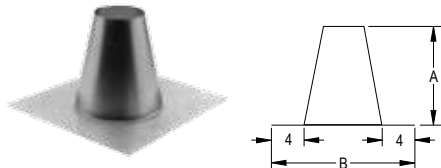

Use to weather proof the penetration of vent pipe through the roof. Storm Collar required. Select roof flashing based on pitch of roof. Use on flat roofs, chase enclosures, or masonry chimney. Made of galvalume.

SIZE	ORDER #	STOCK #	A	B
3"	3GVFF	140F	11 1/4"	16"
4"	4GVFF	141F	11 1/4"	17"
5"	5GVFF	142F	11 1/4"	18 1/4"
6"	6GVFF	143F	10 7/8"	18 1/4"
7"	7GVFF	144F	11 1/4"	21 1/2"
8"	8GVFF	145F	11 1/4"	21 1/2"
10"	10GVFF	2646F	11 1/4"	25 1/2"
12"	12GVFF	2647F	12"	29 1/2"
14"	14GVFF	2580F	12"	32"
16"	16GVFF	2581F	12"	36"
18"	18GVFF	2582F	12"	36"
20"	20GVFF	2583F	12"	38"
22"	22GVFF	2584F	12"	40"
24"	24GVFF	2585F	12"	44 3/4"
26"	26GVFF	2686F	12"	44 3/4"
28"	28GVFF	2687F	12"	48"
30"	30GVFF	2688F	12"	48"

DSA Roof Flashing

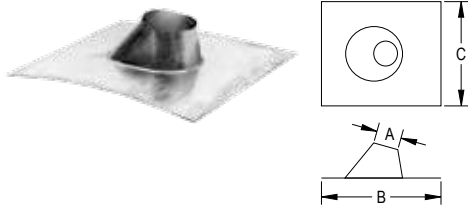

Use with metal or tile roofs. Available in Adjustable Roof Flashing style (0/12-6/12). Made of dead soft aluminum. Refer to Roof Flashing tables for dimensions.

SIZE	ORDER #	STOCK #	A	B	C
3"	3GVFDSA	140DS	3 5/8"	19 3/8"	23"
4"	4GVFDSA	141DS	4 5/8"	19 3/8"	23"
5"	5GVFDSA	142DS	5 5/8"	22"	24 13/16"
6"	6GVFDSA	143DS	6 3/4"	22"	24 13/16"

DuraCap

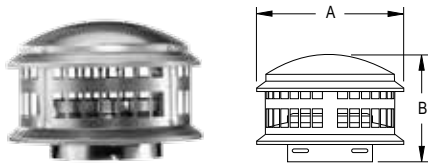

Required where pipe terminates above the roof line. Use for vertical installations only.

SIZE	ORDER #	STOCK #	A	B
3"	3GVDC	630	8"	5 3/4"
4"	4GVDC	631	8"	5 3/4"
5"	5GVDC	632	11"	7 1/4"
6"	6GVDC	633	11"	7"
7"	7GVDC	634	15"	8"
8"	8GVDC	635	15"	8"

High-Wind Cap

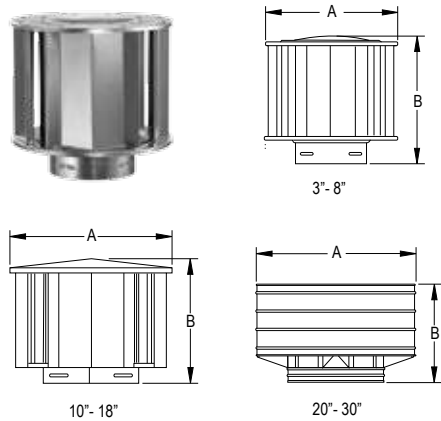

Use for horizontal through-the-wall terminations. Provides improved performance in high wind conditions. For vertical terminations only.

SIZE	ORDER #	STOCK #	A	B
3"	3GVVTH	130	7 1/2"	7 1/4"
4"	4GVVTH	131	8 1/2"	8 1/4"
5"	5GVVTH	132	9 1/2"	9 3/8"
6"	6GVVTH	133	10 1/2"	9 1/4"
7"	7GVVTH	134	11 1/2"	11 3/4"
8"	8GVVTH	135	12 1/2"	12 3/4"
10"	10GVVT	2536	17 1/2"	16"
12"	12GVVT	2537	19 1/4"	18 3/4"
14"	14GVVT	2560	24"	23"
16"	16GVVT	2561	26"	19 1/2"
18"	18GVVT	2562	30"	21 1/2"
20"	20GVVT	2563	34"	23 1/2"
22"	22GVVT	2564	36"	25 1/2"
24"	24GVVT	2565	39"	27 1/2"
26"	26GVVT	2566	44"	29 1/2"
28"	28GVVT	2567	48"	31 1/2"
30"	30GVVT	2568	50"	33 1/2"

Combo Cap

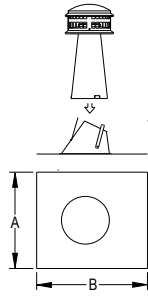

Use to prevent rain and debris from entering the vent. Fits roof pitch 0/12 to 6/12. Two-piece component is easy to install and lightweight. UL Listed.

SIZE	ORDER #	STOCK #	A	B
3"	3GVVTF	360	16"	18 ³ / ₈ "
4"	4GVVTF	361	17"	18 ³ / ₈ "
5"	5GVVTF	362	18 ¹ / ₄ "	20"
6"	6GVVTF	363	19 ¹ / ₄ "	21 ¹ / ₂ "

OVAL TYPE B GAS VENT

Oval Installation Kit



Kit includes: Oval Base Plate and (2) Oval Ceiling Plate Spacers.

Use for wall furnaces installed in a single-story application.

SIZE	ORDER #	STOCK #
4"	5GWK	319

Oval Rigid Pipe

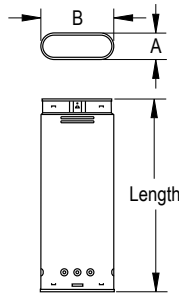

Use for venting listed natural gas or liquid propane Category I, draft hood appliances, or appliances that have been specifically tested and listed to use Type B Gas Vent. The appliances listed typically use Type B Gas Vent systems, but not always: Furnaces, Water Heaters, Boilers, Room Heaters, Decorative Gas Appliances, and Unit Heaters. Designed to be placed within 2" x 4" stud walls (4" and 5" oval pipe). 6" may only be placed in a 2" x 6" 16" O.C. stud space.

SIZE	LENGTH	ORDER #	STOCK #	A	B
4"	6"	4GW06	305	2 1/2"	7 1/4"
4"	12"	4GW12	304	2 1/2"	7 1/4"
4"	18"	4GW18	303	2 1/2"	7 1/4"
4"	24"	4GW24	307	2 1/2"	7 1/4"
4"	36"	4GW36	302	2 1/2"	7 1/4"
4"	48"	4GW48	301	2 1/2"	7 1/4"
4"	60"	4GW60	300	2 1/2"	7 1/4"
5"	6"	5GW06	505	3 1/8"	10 7/8"
5"	12"	5GW12	504	3 1/8"	10 7/8"
5"	18"	5GW18	503	3 1/8"	10 7/8"
5"	24"	5GW24	507	3 1/8"	10 7/8"
5"	36"	5GW36	502	3 1/8"	10 7/8"
5"	48"	5GW48	501	3 1/8"	10 7/8"
5"	60"	5GW60	500	3 1/8"	10 7/8"
6"	6"	6GW06	605	3 1/4"	11 7/8"
6"	12"	6GW12	604	3 1/4"	11 7/8"
6"	18"	6GW18	603	3 1/4"	11 7/8"
6"	24"	6GW24	607	3 1/4"	11 7/8"
6"	36"	6GW36	602	3 1/4"	11 7/8"
6"	48"	6GW48	601	3 1/4"	11 7/8"
6"	60"	6GW60	600	3 1/4"	11 7/8"

Oval Adjustable Pipe

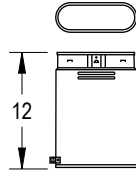

Use to add length to a straight length of Oval Type B Gas Vent Pipe. Adjusts from 4"-10". Requires a 2" overlap.

SIZE	LENGTH	STOCK #	ORDER #
4"	12"	4GW12A	306
5"	12"	5GW12A	506
6"	12"	6GW12A	606

Oval Increaser

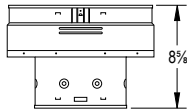

Use to increase oval vent diameter.

SIZE	STOCK #	ORDER #
4" x 5"	4GWX5	419
5" x 6"	5GWX6	519
4" x 6"	4GWX6	619

Round To Oval Adapter

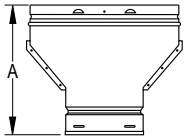

Use to convert from round to oval vent.

SIZE	STOCK #	ORDER #	A
3" to 4"	4GWAR3	324	9 1/4"
4"	4GWAR0	315	9 1/4"
5"	5GWAR0	515	9 3/8"
6"	6GWAR0	615	11 1/2"

Oval To Round Adapter

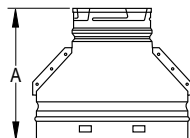

Use to convert from oval to round vent.

SIZE	STOCK #	ORDER #	A
4"	4GWAOR	314	9 1/4"
5"	5GWAOR	514	9 7/8"
6"	6GWAOR	614	10"

Oval 45° Elbow - Standard

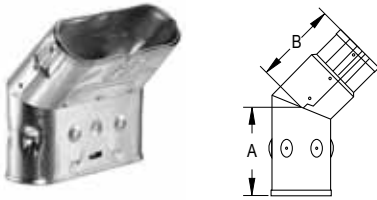

Offsets obstructions as needed. Not adjustable.

SIZE	STOCK #	ORDER #	A	B
4"	4GWL45	310	3 5/8"	3 1/2"
5"	5GWL45	510	4 1/8"	5"
6"	6GWL45	610	5"	5"

Oval 45° Elbow - Flat

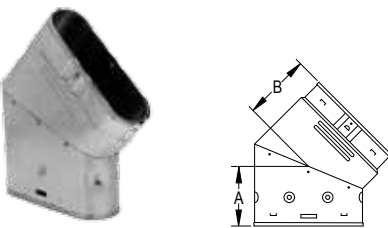

Offsets obstructions as needed. Not adjustable.

SIZE	STOCK #	ORDER #	A	B
4"	4GWL45F	311	4 1/2"	4 1/8"
5"	5GWL45F	511	5 1/4"	5 5/8"
6"	6GWL45F	611	5 3/4"	4 3/4"

Oval Tee Support - Plain

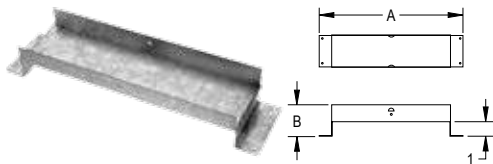

Use to support and center Oval Tee. Use with Oval Tee Cap.

SIZE	STOCK #	ORDER #	A	B
5"	5GWTS	521	13 7/8"	2 1/8"
6"	6GWTS	621	13 7/8"	2 1/8"

Oval Tee Support - Base Plate

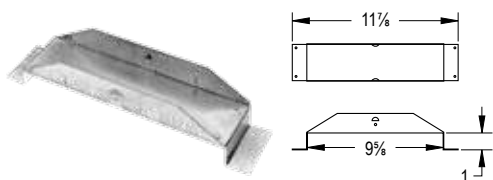

Use to support and center Oval Tee. Use with Oval Tee Cap.

SIZE	STOCK #	ORDER #	A	B
4"	4GWPS	308	9 5/8"	11 7/8"

Oval Firestop Spacer

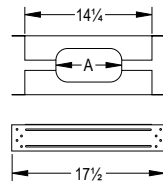

Use to center oval vent in a minimum 16" on-center stud space. Serves as a firestop at the ceiling level. Required in multi-story installations.

SIZE	STOCK #	ORDER #	A
4"	4GWFS	350	7 1/2"
4"	4GWFS2X6	351	7 1/2"
5"	5GWFS	522	11"
5"	5GWFS2X6	523	11"
6"	6GWFS	622	12 1/8"

Oval Base Plate

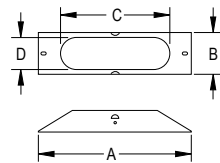

Use to attach oval vent to a wall furnace.

SIZE	STOCK #	ORDER #	A	B	C	D
4"	4GWBP	321	9 5/8"	2 3/8"	6 7/8"	2"

Oval Ceiling Plate Spacer

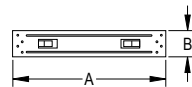

Use to center the oval vent where Oval Firestop Spacer is not required. (2 plates included.)

SIZE	STOCK #	ORDER #	A	B
4"	4GWCS	320	17 1/2"	3"

Oval Standard Tee

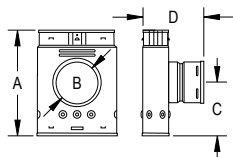

Use to attach round pipe to oval pipe. Use for a 90° offset or to combine connectors from two or more appliances into a common vent.

SIZE	STOCK #	ORDER #	A	B	C	D
4"	4GWT	312	10 1/4"	4"	5 1/4"	6"
5"	5GWT	512	11 3/4"	5"	6 1/4"	6 1/4"
6"	6GWT	612	12 1/8"	6"	6"	7"

Oval Short Snout Tee

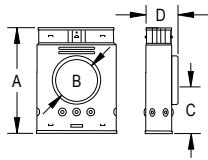

Use to attach round pipe to oval pipe. Use for a 90° offset or to combine connectors from two or more appliances into a common vent. Shorter snout allows installation in tight spaces.

SIZE	STOCK #	ORDER #	A	B	C	D
4"	4GWST	312ST	8 1/2"	4"	5"	3 1/2"

Oval In increaser Tee

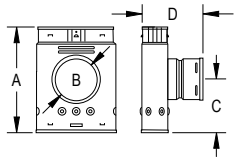

Use to attach smaller round pipe to larger oval pipe. Use for a 90° offset or to combine connectors from two or more appliances into a common vent.

SIZE	STOCK #	ORDER #	A	B	C	D
4" x 3"	4GWTR3	331	10 1/8"	3"	5"	6 1/2"
5" x 3"	5GWTR3	512T3	11 7/8"	3"	6 1/4"	7 1/4"
5" x 4"	5GWTR4	512T4	11 7/8"	4"	6 1/4"	6 3/4"
6" x 4"	6GWTR4	612T4	12"	4"	5 3/4"	8 1/4"
6" x 5"	6GWTR5	612T5	12"	5"	5 3/8"	6 7/8"

Oval Tee Cap

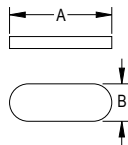

Use to close off bottom of Oval Tee. Fits on inner liner.

SIZE	STOCK #	ORDER #	A	B
4"	4GWTC	313	6 7/8"	2"
5"	5GWTC	513	10 3/8"	2 3/4"
6"	6GWTC	613	11 1/2"	2 3/4"

Oval Storm Collar

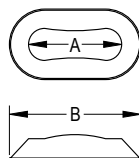

Use to maintain a weather tight resistant seal between the pipe and the flashing.

SIZE	STOCK #	ORDER #	A	B
4"	4GWSC	318	7 1/2"	10 1/4"
5"	5GWSC	518	10 3/4"	13 3/8"
6"	6GWSC	618	12"	15"

Oval Adjustable Roof Flashing

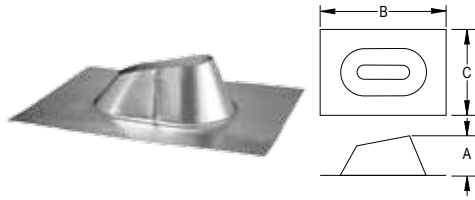

Use to weather proof the penetration of vent pipe through the roof. Storm Collar required. Select roof flashing based on pitch of roof. For pitches of 0/12 - 6/12. Made of galvalume.

SIZE	STOCK #	ORDER #	A	B	C
4"	4GWF	317	3 1/2"	18"	12 1/2"
5"	5GWF	517	7 3/4"	25 1/2"	17 1/2"
6"	6GWF	617	7 1/8"	25 1/2"	17 1/2"

Oval DSA Roof Flashing

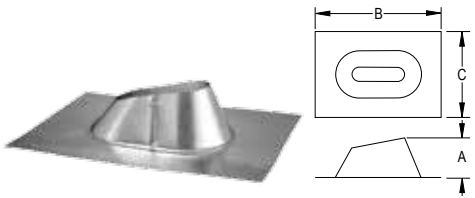

Use with metal or tile roofs. Available in Adjustable Roof Flashing style (0/12-6/12). Made of dead soft aluminum. Refer to Roof Flashing tables for dimensions.

SIZE	STOCK #	ORDER #	A	B	C
4"	4GWFDSA	317DS	3 3/4"	28 1/2"	23 1/2"
5"	5GWFDSA	517DS	3 1/2"	30 1/2"	27"
6"	6GWFDSA	617DS	7"	35"	27"

Oval Cap

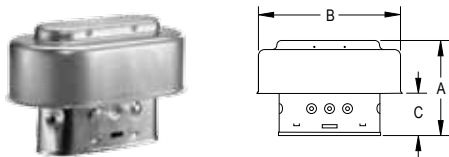

Required where pipe terminates above the roof line. Use for vertical installations only.

SIZE	STOCK #	ORDER #	A	B	C
4"	4GWVT	316	6 1/8"	10"	2 3/4"
5"	5GWVT	516	7 1/2"	15 1/4"	3 3/4"
6"	6GWVT	616	7 1/2"	15 1/4"	4"

DURACONNECT® - Connector Systems

DuraConnect II - Double-Wall Flex Connector

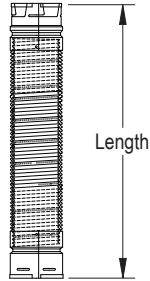

Use as a connector system to replace rigid gas vent with a flexible section. DuraConnect II can be used when Type B gas vent double-wall connector is required. Not to be enclosed and cannot penetrate through walls, floors, or ceilings. Twist-lock connectors on each end.

SIZE	LENGTH	STOCK #	ORDER #
3"	12"	3DV12DW	6505
3"	24"	3DV24DW	6504
3"	36"	3DV36DW	6503
3"	48"	3DV48DW	6502
3"	60"	3DV60DW	6501
4"	12"	4DV12DW	6605
4"	24"	4DV24DW	6604
4"	36"	4DV36DW	6603
4"	48"	4DV48DW	6602
4"	60"	4DV60DW	6601
5"	12"	5DV12DW	6705
5"	24"	5DV24DW	6704
5"	36"	5DV36DW	6703
5"	48"	5DV48DW	6702
5"	60"	5DV60DW	6701

DuraConnect I - Single-Wall Flex Connector

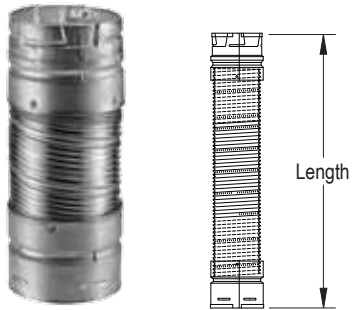

Use anywhere a single-wall connector is allowed. Not to be enclosed. Twist-lock connectors on each end. Patented.

SIZE	LENGTH	STOCK #	ORDER #
3"	12"	3DV12	6006
3"	24"	3DV24	6004
3"	36"	3DV36	6003
3"	48"	3DV48	6002
3"	60"	3DV60	6001
4"	12"	4DV12	6106
4"	24"	4DV24	6104
4"	36"	4DV36	6103
4"	48"	4DV48	6102
4"	60"	4DV60	6101
5"	12"	5DV12	6206
5"	24"	5DV24	6204
5"	36"	5DV36	6203
5"	48"	5DV48	6202
5"	60"	5DV60	6201

Increaser

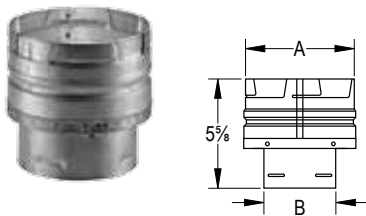

Use single-wall Increaser to increase vent. Additional sizes available through special order.

SIZE	STOCK #	ORDER #	A	B
3" x 4"	3DVX4	6010	4 1/2"	3 5/8"
3" x 5"	3DVX5	6011	5 1/2"	3 5/8"
3" x 6"	3DVX6	6012	6 1/2"	3 5/8"
4" x 5"	4DVX5	6110	5 1/2"	4 5/8"
4" x 6"	4DVX6	6111	6 1/2"	4 5/8"
4" x 7"	4DVX7	6112	7 1/2"	4 5/8"
5" x 6"	5DVX6	6210	6 1/2"	5 5/8"
5" x 7"	5DVX7	6211	7 1/2"	5 5/8"

Appliance Connector

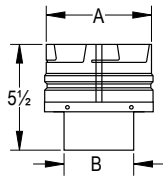

Use to attach an appliance to DuraConnect connector pipe.

SIZE	STOCK #	ORDER #	A	B
3"	3DVC	6070	3 1/2"	3"
4"	4DVC	6170	4 1/2"	4"
5"	5DVC	6270	5 1/2"	5"

Wall Strap

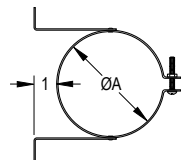

Use to provide support for offsets and horizontal runs. Recommended every 4' to support vertical common vent. Use also with DuraConnect or DuraConnect II. Wall Strap legs can be rotated 360° to conceal screw.

SIZE	STOCK #	ORDER #	A
3"	3GVWS	1485	3 5/8"
4"	4GVWS	1486	4 5/8"
5"	5GVWS	1487	5 5/8"

Round Support

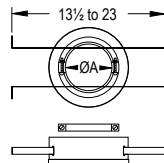

Use to support the Type B gas vent between 16" to 24" on center joists or rafters. A Firestop Spacer is required.

SIZE	STOCK #	ORDER #	A
3"	3DVRS	6020	3 3/4"
4"	4DVRS	6120	4 3/4"
5"	5DVRS	6220	5 3/4"

Standard Tee

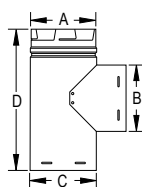

Use for a 90° offset or to combine connectors from two or more appliances into a common vent.

SIZE	BRANCH & BASE	STOCK #	ORDER #	A	B	C	D
3"	Tee w/3" BR at 90°	3DVT	6090	3 1/2"	3 5/8"	3 5/8"	9"
4"	Tee w/3" BR at 90°	4DVT3	6191	4 1/2"	3 5/8"	4 5/8"	9"
4"	Tee w/4" BR at 90°	4DVT	6190	4 1/2"	4 5/8"	4 5/8"	10"
5"	Tee w/3" BR at 90°	5DVT3	6292	5 1/2"	3 5/8"	5 5/8"	9"
5"	Tee w/4" BR at 90°	5DVT4	6291	5 1/2"	4 5/8"	5 5/8"	9 3/4"
5"	Tee w/5" BR at 90°	5DVT	6290	5 1/2"	5 5/8"	5 5/8"	11"

Increaser Tee

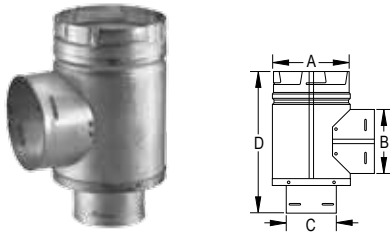

Attaches smaller pipe to branch and smaller pipe to body. Use for a 90° offset or to combine connectors from two or more appliances into a common vent. Additional sizes available through special order.

SIZE	BRANCH & BASE	STOCK #	ORDER #	A	B	C	D
5"	Tee w/4" BR-3" Base	5DVT43	6293	5 1/2"	4 5/8"	3 5/8"	10 1/4"
5"	Tee w/3" BR-4" Base	5DVT34	6294	5 1/2"	3 5/8"	4 5/8"	8 7/8"

Tee Cap

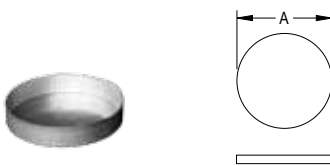

Use to cap Standard Tee or Increaser Tee. Remove Tee Cap to inspect the system; clean out debris or collected condensate from the common vent. Fits on outer wall.

SIZE	STOCK #	ORDER #	A
3"	3DVTC	6051	3 5/8"
4"	4DVTC	6151	4 5/8"
5"	5DVTC	6251	5 5/8"

Standard Wye - 45° Branch

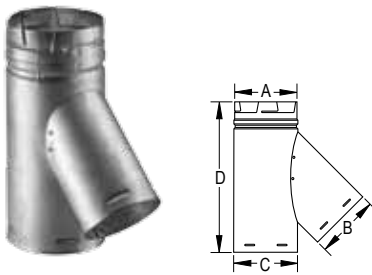

Use to combine DuraConnect connectors from two or more appliances into a common vent. Additional sizes available through special order.

SIZE	BRANCH & BASE	STOCK #	ORDER #	A	B	C	D
3"	Y w/3" BR at 45°	3DVY	6045	3 1/2"	3 5/8"	3 5/8"	10 1/2"
4"	Y w/3" BR at 45°	4DVY3	6146	4 1/2"	3 5/8"	4 5/8"	10 1/2"
4"	Y w/4" BR at 45°	4DVY4	6145	4 1/2"	4 5/8"	4 5/8"	11 3/4"
5"	Y w/3" BR at 45°	5DVY3	6247	5 1/2"	3 5/8"	5 5/8"	10 1/2"
5"	Y w/5" BR at 45°	5DVY	6245	5 1/2"	5 5/8"	5 5/8"	13 1/4"

Increaser Wye - 45° Branch

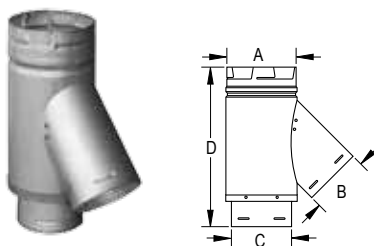

Use to combine DuraConnect connectors from two or more appliances. Use to connect single-wall pipe or DuraConnect to common vented Type B gas vent.

SIZE	BRANCH & BASE	STOCK #	ORDER #	A	B	C	D
4"	Y w/3" BR at 45°-3" Base	4DVY33	6143	4 5/8"	3 5/8"	3 5/8"	11 1/4"
5"	Y w/3" BR at 45°-4" Base	5DVY34	6243	5 5/8"	3 5/8"	4 5/8"	11 1/4"
5"	Y w/4" BR at 45°-4" Base	5DVY44	6242	5 5/8"	4 5/8"	4 5/8"	12 5/8"
5"	Y w/4" BR at 45°-3" Base	5DVY43	6248	5 5/8"	4 5/8"	3 5/8"	13"
5"	Y w/5" BR at 45°-3" Base	5DVY53	6241	5 5/8"	5 5/8"	3 5/8"	14 1/4"