



## **SINGLE ZONE MEGA AND MEGA 115V WALL MOUNTED OWNER'S MANUAL**

### Single Zone Mega Wall Mount Systems

LS090HEV1    LS090HXV

LS120HEV1    LS120HXV

LS180HEV1

LS240HEV1



## **PROPRIETARY DATA NOTICE**

This document, as well as all reports, illustrations, data, information, and other materials is the property of LG Electronics U.S.A., Inc., and are disclosed by LG Electronics U.S.A., Inc., only in confidence.  
This document is for design purposes only.

OL\_SZ\_Mega\_All\_8\_16

For continual product development, LG Electronics U.S.A., Inc., reserves the right to change specifications without notice.  
©LG Electronics U.S.A., Inc.

# TABLE OF CONTENTS

<b>Safety Instructions</b> .....	<b>4</b>	<b>Advanced Functions</b> .....	<b>15</b>
<b>Unit Parts</b> .....	<b>7</b>	<i>Jet Cool/Jet Heat Operation - Auto Changeover Operation</i>	
<i>Basic Components</i>		<i>Energy Saving Operation - Auto Restart</i>	
<b>Unit Operation</b> .....	<b>9</b>	<b>Maintenance</b> .....	<b>17</b>
<i>Remote Controller</i>		<i>Indoor Unit - Cleaning Intervals</i>	
<b>Basic Functions</b> .....	<b>13</b>	<i>Cleaning the Air Filter</i>	
<i>Cooling Operation - Adjusting the Air Flow (Swing) Direction</i>		<b>Troubleshooting</b> .....	<b>19</b>
<i>Timer Settings</i>			

# SAFETY INSTRUCTIONS

## IMPORTANT!

- Please read this manual completely before operating this product.
- Follow the instructions in this manual to prevent product malfunction, property damage, injury or death to the user or other people.
- Incorrect operation due to ignoring any instruction will cause harm or damage.
- The level of seriousness is classified by the symbols described below.

**⚠ DANGER** This symbol indicates an imminently hazardous situation which, if not avoided, will result in death or serious injury.

**⚠ WARNING** This symbol indicates a potentially hazardous situation which, if not avoided, could result in death or serious injury.

**⚠ CAUTION** This symbol indicates a potentially hazardous situation which, if not avoided, may result in minor or moderate injury.

**Note:** This symbol Indicates situations that may result in equipment or property damage accidents only.

**⊘** This symbol indicates an action should not be completed.

## General Safety

### ⚠ WARNING

- Installation and repair must always be done by a qualified technician.
- Installation **MUST** conform with local building codes or, in the absence of local codes, with the Nation Electrical Code NFPA 70/ANSI C1-1003 or current edition and Canadian Electrical Code Part1 CSA C.22.1.
- Failure to carefully read and follow all instructions in this manual may result in equipment malfunction, property damage, personal injury and/or death.

## Power and Electrical Safety

### ⚠ WARNING

- Immediately disconnect the product in the event of a blackout or thunderstorm. Failure to do so may result in fire, electric shock and/or damage.
- Always ensure that the equipment is properly grounded. Failure to do so may result in electric shock and/or product failure.
- Be sure a circuit breaker is installed before using the air conditioner. Failure to do so may result in electric shock and/or product failure.
- Do not connect the ground wire to a gas pipe, a lightning rod or a telephone ground wire; because it may result in electric shock and/or product failure.
- Use a standard circuit breaker and fuse conforming to the rating of the air conditioner. Failure to do so may result in electric shock and/or product failure.
- Do not modify or extend the power cable; because it may result in electric shock and/or fire. If the power cable shows wear, such as scratches or outer skin is peeling off or deteriorated, then it must be replaced.
- Do not use a damaged power cord; because it may result in electric shock and/or fire.
- Do not touch, operate or repair the air conditioner with wet hands; because it may result in electric shock or product failure.
- Do not place a heater or other heat generating appliances near the power cable; because it may result in electric shock and/or fire.
- Check that the power cord is not pulled or damaged while the air conditioner is operating. Failure to do so may result in electric shock, and/or fire.
- Do not place any objects on the power cord; because it may result in electric shock or product failure.

# SAFETY INSTRUCTIONS

## Installation Safety

### WARNING

- Do not install the air conditioner on an unstable surface or where there is a danger of it falling; because it may result in death, serious injury, and/or product failure.
- Contact an authorized service center when you install or relocate the air conditioner. Failure to do so may result in serious injury and/or product failure.
- Indoor/outdoor wiring connections must be secured tightly and the cable should be routed properly so that there is no force pulling the cable from the connection terminals. Improper or loose connections may cause heat generation or fire.
- Install the panel and the cover of the control box safely. Failure to do so may result in explosion or fire.
- Do not install the air conditioner near a place with a danger of explosion or fire; because it may result in serious bodily injury or death.
- Ensure that the pipe and the power cable which connect the indoor unit and the outdoor unit are not pulled tight when installing the air conditioner. Failure to do so may result in electric shock or product failure.
- Do not mix air or gas in the system except for the specific refrigerant. If air enters the refrigerant system, it may result in excessively high pressure that may lead to personal injury or damage to the equipment.
- Safely dispose of packing materials such as screws, nails or batteries in a packing bag after installation or repair. Failure to do so may result in serious bodily injury.
- Use caution when unpacking or installing the air conditioner. Failure to do so may result in bodily injury or product failure.
- When lifting or transporting the equipment, there should be 2 or more people, or a forklift. Failure to do so may result in bodily injury.
- Avoid exposure to leaking refrigerant which may occur during installation or repair. Failure to do so may result in personal injury and/or product failure.
- If there is a refrigerant leak during the installation of the air conditioner, ventilate the area immediately. Failure to do so may result in serious injury and/or product failure.

### Note:

- Do not install air conditioner with direct exposure to sea water or sea wind (salt spray); because it may result in product failure.
- Install the drain hose properly for smooth drainage of condensed water. Failure to do so may result in product failure.

## Usage

### WARNING

- Use only those parts which are listed in the service parts list. Never attempt to modify the equipment; because that may result in death, serious injury, and/or product failure.
- Discard the batteries in a safe manner and where there is no danger of excessive heat or fire. Failure to do so may result in explosion or fire.
- Contact an authorized service center when the air conditioner is submerged into water due to flooding. Failure to do so may result in explosion or fire.
- Only use components that are approved by the manufacturer and do not repair or modify them; because it may result in electric shock and/or product failure.
- Only use the refrigerant specified on the air conditioner label. Failure to do so may result in explosion or fire.
- Do not allow water to run into the air conditioner; because it may result in explosion or fire.
- Do not leave flammable substances such as gasoline, benzene and other white spirits or solvents, including thinner near the air conditioner; because it may result in explosion or fire and may result in bodily injury.
- Do not use the air conditioner for an extended period of time in a small place without ventilation; because it may result in explosion or fire. Make sure to ventilate the space regularly.
- Do not touch the electrostatic filter after opening the front grill; because it may result in electric shock or product failure.
- For inner cleaning, contact an authorized service center or a dealer. Do not use harsh detergent that causes corrosion or damage on the unit; because it may cause product failure, fire, and/or electronic shock.
- Disconnect power if there is a noise, smell or smoke coming from the air conditioner. Failure to do so may result in explosion or fire.
- Ventilate room or area when air conditioner and a heating appliance such as a heater are used simultaneously. Failure to do so may result in fire, serious injury, and/or product failure.
- Make sure that children do not climb up the outdoor unit or impact it. Failure to do so may result in death, bodily injury and/or product failure.
- If there is a gas leak, ventilate area sufficiently before using the air conditioner again. Failure to do so may result in explosion or fire.
- Do not use the product for special purposes, such as preserving foods, works of art, etc.; because it may result in death, fire and/or electric shock. The product is a consumer air conditioner, not a precision refrigeration system.
- Do not block the inlet or outlet of air flow; because it may result in explosion or product failure.

# SAFETY INSTRUCTIONS

---

---

## Usage (Continued)

### **⚠ WARNING**

- Do not insert hands or other objects through the air inlet or outlet while the air conditioner is operating; because it may result in personal bodily injury or electric shock.
- Do not expose people, animals or plants to the cold or hot wind from the air conditioner; because it may result in serious injury.
- Do not drink the water drained from the air conditioner; because it may result in serious health complications.
- During maintenance, be sure to turn the main power off when cleaning or repairing the air conditioner. Failure to do so may result in death, serious bodily injury, and/or product failure.
- Do not recharge or disassemble the batteries; because it may result in explosion, fire or serious bodily injury.
- Do not dispose of the batteries in fire. It may result in explosion or fire.
- Stop using the remote controller if there is a battery fluid leak; and if your clothes or skin is exposed to the battery fluid from a leak, wash it off with clean water. Failure to do so may result in serious bodily injury.

### **Note:**

- Follow the standards of the corresponding region or country for handling the refrigerant and the air conditioner, and for disassembling the air conditioner. Failure to do so may result in product failure.
- Do not mix the batteries for the remote controller with other types of batteries or mix new batteries with used batteries; because it may result in product failure.
- Remove the batteries when the remote controller is not in use for an extended period of time. Failure to do so may result in product failure.
- Filter must be installed before operating the air conditioner. Failure to do so may result in product failure.
- Do not place any objects on the air conditioner; because it may result in product failure.
- Do not let the air conditioner run for a long time when the humidity is very high or when a door or window has been left open; because it may result in product failure.

## Maintenance

### **⚠ WARNING**

- Do not use strong cleaning agents or solvents when you clean the air conditioner, or spray water; because it may result in serious bodily injury or product failure. Make sure to use a smooth cloth when cleaning the product.
- Never touch the metal parts of the air conditioner when removing the air filter; because it may result in serious bodily injury or product failure.
- Use a sturdy stool or ladder when cleaning, maintaining or repairing the air conditioner at a height. Failure to do so may result in serious bodily injury or product failure.



# UNIT PARTS

The following tables show the available outdoor and indoor units, along with the factory provided controllers.

Table 1: Single Zone Mega Wall Mount System Pairing Table

Outdoor Unit Model	Indoor Unit Model	Controller
LSU090HEV1 LSU120HEV1 	LSN090HEV1 LSN120HEV1 	AKB73835318 
LSU180HEV1 	LSN180HEV1 	AKB73835318 
LSU240HEV1 	LSN240HEV1 	AKB73835318 

Table 2: Single Zone Mega 115V Wall Mount System Pairing Table

Outdoor Unit Model	Indoor Unit Model	Controller
LSU090HXV LSU120HXV 	LSN090HXV LSN120HXV 	AKB73456121 

# UNIT PARTS

## Basic Components

### Indoor and Outdoor Unit Basic Components

Refer to Figure 1 for the basic layout of Single Zone Mega and Mega 115V Wall Mount systems when following operational, maintenance or troubleshooting instructions in this manual.

Figure 1: Indoor Unit Basic Components

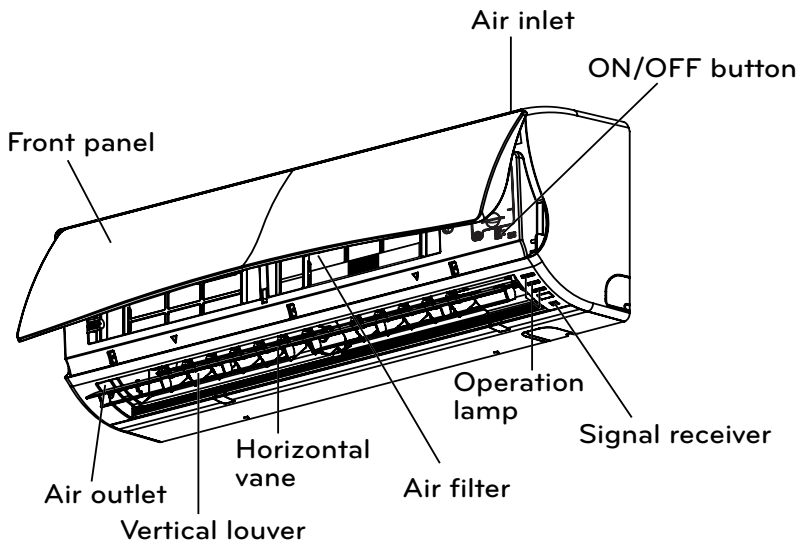

**Note:**

The number of operation lamps and their locations may vary, depending on the indoor unit model.

Figure 2: Outdoor Unit Basic Components

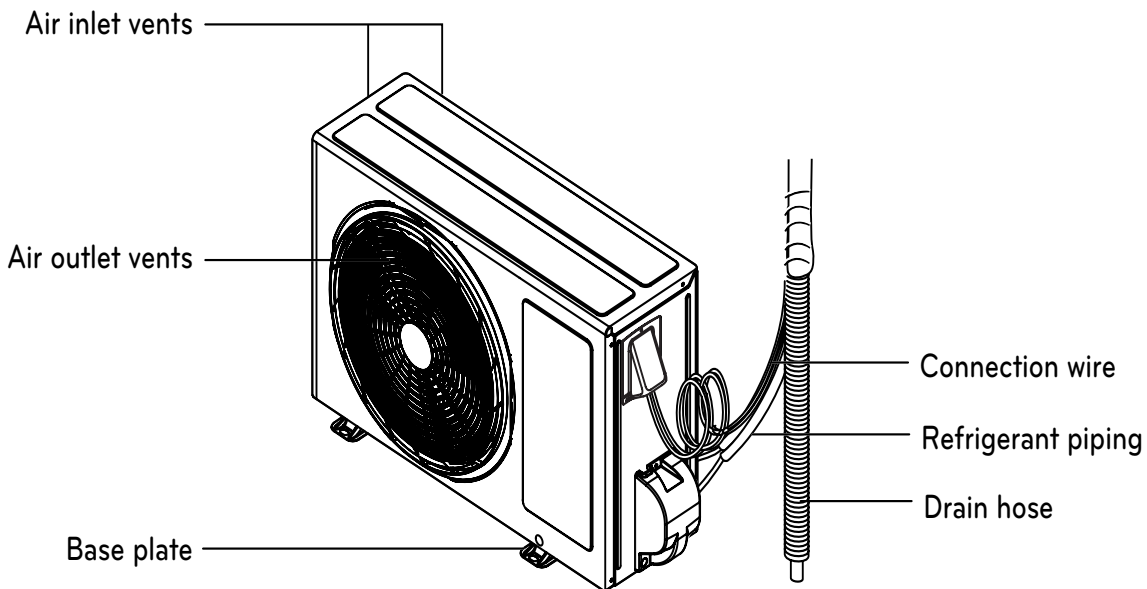



# UNIT OPERATION

## Remote Controller

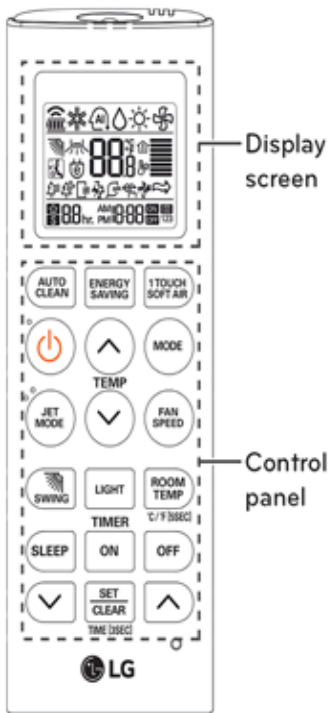

LS090HEV1, LS120HEV1,  
LS180HEV1, LS240HEV1

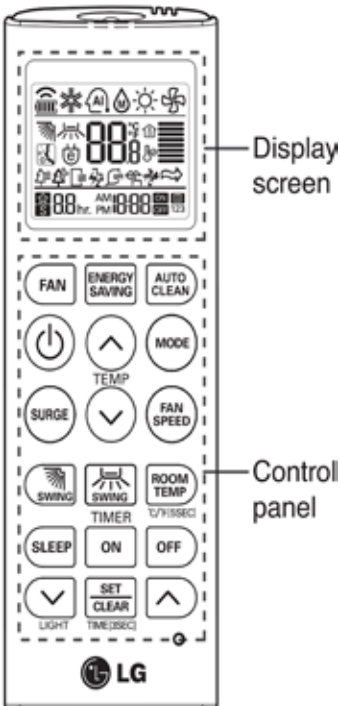

LS090HXV, LS120HXV

Table 3: Remote Controller Operation

Control Panel	Display Screen	Description
		<b>Air Circulation Button*</b> : Used to circulate the room air without cooling or heating.
 	 	<b>Auto Cleaning/Energy Saving Buttons*</b> : Sets time related to special functions such as automatic cleaning  and placing the unit into energy efficient cooling mode .
	N/A	<b>On/Off Button</b> : Turns the remote controller power on/off.
 		<b>Temperature Adjustment Buttons</b> : Press up or down “arrow” temp buttons to adjust temperature during cooling or heating. Display screen will show adjusted temperature.
	   	<b>Operation Mode Selection Button</b> : Cycles through the operation mode, from top left symbols: Cooling mode: Auto operation or auto changeover: Dehumidifying mode: Heating mode:
		<b>Fan Speed Button</b> : Adjusts the indoor fan speed by pressing repeatedly. Also allows for natural air circulation (when wavy arrow is displayed). Note Mega 115V remote controller display will look slightly different.
		<b>Surge Button (Heating/Cooling)*</b> : Rapid heating or cooling of indoor temperature. Temperature heats or cools in a short period of time.
 		<b>Air Flow Direction (Swing) Buttons</b> : Adjusts the directions of air flow; vertically or horizontally through louvers.
		<b>Room Temperature Display Button</b> : Displays the current room temperature. Temperature value can be changed from °C or °F when button is pressed and held for 5 seconds.
	 	<b>Sleep Mode Auto Button*</b> : Pressing will activate sleep mode timer selection. Pressing the   allows you to select up to 7 hours prior to the unit automatically turning off.
		<b>1 Touch Soft Air Button</b> : Adjusts the air flow to deflect supply air away from blowing directly onto room occupants.







\*Some functions may not be available on all models.

Figure 3: Single Zone Wall Mount Systems Remote Controllers for Mega and Mega 115V

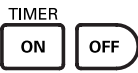
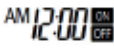
# UNIT OPERATION

## Remote Controller

Table 3: Remote Controller Operation (Continued)

Control Panel	Display Screen	Description
		<p><b>Timer Buttons (On/Off):</b> Sets the clock timer to enable automatic start and stop times for air conditioner activity.</p> <p>Pressing the   buttons, enable the user to set the actual time as shown on the display screen.</p>
	N/A	<p><b>Set/Clear Button:</b> Either sets (commits) a function or clears (cancels) a function.</p> <p>When pressing and holding for 3 seconds or longer, allows the user to set current time by using the   buttons.</p>
	N/A	<p><b>Up/Down (Directional) Buttons:</b> Used in conjunction with other primary mode and operation buttons. Once in desired mode, user can press the Up and Down button to move forward or backward in selections. For example these buttons can be used to set timer clock settings or brightness of the indoor unit display.</p>

### Installing Remote Controller Batteries

1. Insert AAA batteries (1.5V) before turning on the remote.
2. Remove the battery cover from the back of the unit, by pushing down the tab at the top of the cover. Refer to #1 on Figure 4.
3. Lift battery cover off of the unit as shown on Figure 4 (#2).
4. Insert the batteries, following the + and - terminal indications inside the battery compartment. Make sure batteries are securely in place (Figure 5).
5. Reattach the battery cover.

**Note:**

- If the display screen of the remote controller starts to fade, replace the batteries.
- When batteries are removed, the temperature unit will be reset to Celsius as the default.

### Installing the Remote Controller Holder

**Note:**

Installation of the remote controller holder should be out of direct sunlight, in order to protect the remote controller from heat exposure.

1. Choose a safe and easily accessible place to attach the remote controller holder.
2. Using a phillips head screwdriver, insert and fasten the 2 screws into the holes at the base (Figure 6).
3. Gently “wiggle” the base to make sure that it is firmly attached to the wall. Tighten the screws further if you feel the wall mount is still loose.
4. Slide the remote control vertically into the holder (Figure 7).

Figure 7: Holder Attachment

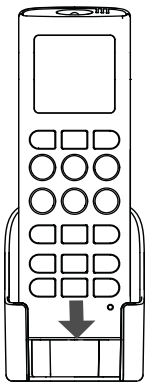

Figure 4: Remote Controller Battery Cover

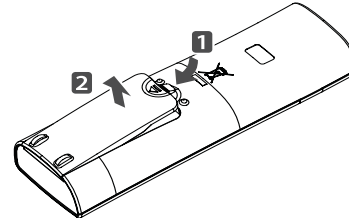

Figure 5: Battery Placement

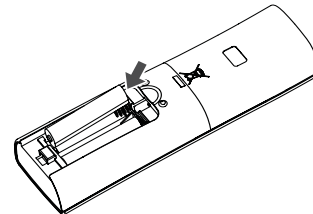
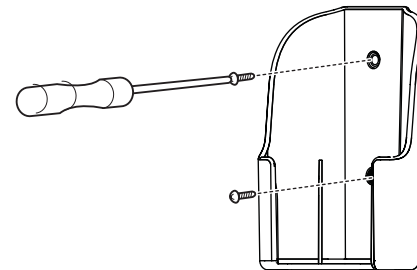

Figure 6: Holder Attachment



# UNIT OPERATION

## Remote Controller, Indoor Unit

### Initializing Remote Control Operation

To begin communication between the indoor unit and the remote control, point the remote control towards the signal receiver, located at the bottom right hand corner of the indoor unit (refer to Figure 8).

**Note:**

- *Make sure to point the remote control directly at the indoor unit, otherwise the remote may accidentally pick up a signal and activate and operate other electronic devices.*
- *For optimum operation, periodically use a soft cloth to wipe the signal transmitter on the remote control and the receiver on the indoor unit.*
- *Jet mode in heating operation does not work when equipped with a wired remote controller.*
- *On/Off reserve mode does not work when equipped with a wired remote controller.*

Figure 8: Initializing a Remote Control

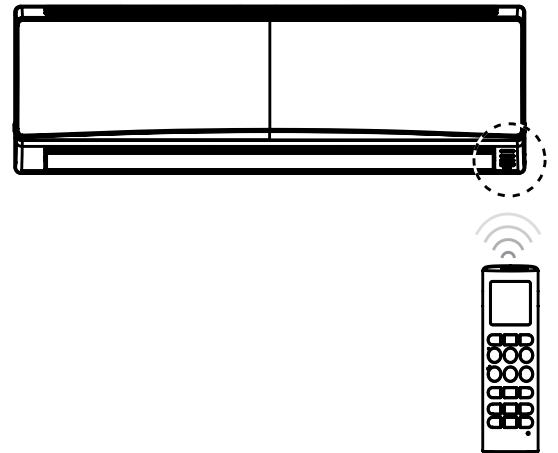

# BASIC FUNCTIONS

## Cooling Operation - Adjusting the Air Flow (Swing) Direction

### Cooling Operation

1. On the remote control, press to turn on the indoor unit.
2. Press repeatedly until the cooling symbol (snowflake) is displayed on the remote control display screen.
3. Press the up and down arrow buttons to increase or decrease currently displayed temperature.

**Note:**

The cooling temperature range is 64 °F (18 °C) - 86 °F (30 °C).

### Air Circulation Operation

This mode circulates indoor air without changing the room temperature.

**Note:**

The cooling lamp lights up in air circulation mode on the indoor unit.

1. On the remote control, press to turn on the indoor unit.
2. Press to activate air circulation operation. The fan symbol will be displayed on the remote controller display screen.
3. Press to adjust the fan speed.

### Adjusting the Fan Speed

1. Press repeatedly to adjust the fan speed. See Table 4 for the various speed adjustments.
2. Select for natural air. The fan speed adjusts automatically.

Table 4: Fan Speed Levels

Display Symbol	Speed
	High
	Medium
	Low
	Natural Wind

### Heating Operation

1. On the remote control, press to turn on the indoor unit.
2. Press repeatedly until the heating symbol (sun) is displayed on the remote control display screen.
3. Press the up and down arrow buttons to increase or decrease currently displayed temperature.

**Note:**

- The cooling temperature range is 60.8 °F (16 °C) - 86 °F (30 °C).
- Cooling only models do not support this function.

### Dehumidifying Operation

In order to prevent mold, this mode removes excess moisture from an environment with high humidity or during local rainy seasons. This mode adjusts the room temperature and the fan speed automatically to maintain the optimal level of humidity.

1. On the remote control, press to turn on the indoor unit.
2. Press repeatedly until the dehumidifying symbol (raindrop) is displayed on the remote control display screen.

**Note:**

- When the indoor unit is in dehumidifying mode, you cannot adjust the room temperature. The temperature is being adjusted automatically.
- While in dehumidifying mode, the display screen will not show the room temperature.

### Adjusting the Air Flow (Swing) Direction

1. To adjust the direction of the air flow vertically, press repeatedly and select the desired position.
2. Select on the remote control display screen to adjust the desired vertical position automatically.
3. To adjust the horizontally air flow direction, press repeatedly and select the desired position.
4. Select on the remote control display screen to adjust the desired horizontal position automatically.

**Note:**

- Some models may not support adjusting air flow direction. Check your model to be sure it is an option.
- When restarting the air conditioner, it will remember the previously set air flow direction. As a result, the air deflector may not accurately reflect the icon displayed on the remote control. If this occurs, press or to adjust the direction of the air flow again.

### Using 1 Touch Soft Air to deflect air (Comfort Vane Operation)

The comfort vane operation sets the vane to a preset position. This deflects the supply air away from blowing directly onto the room occupants.

1. Press to turn on the indoor unit.
2. Press repeatedly and select the desired direction.

Either or appears on the display screen.



# BASIC FUNCTIONS

## Timer Settings



### Timer Settings

Single Zone Mega systems can be programmed through timer settings to turn the unit on and off at set times during the day and night. This functionality allows you to save energy and utilize the air conditioner more efficiently.

#### Setting the Current Time

1. Press and hold  for no longer than 3 seconds to initiate setting functionality.
  - The AM/PM icon will flicker at the bottom of the display screen.





2. Press the up and down buttons   to scroll and then select the minutes (hours will scroll).
3. Press  when finished to exit the setting mode.

#### Setting an Automatic On Time

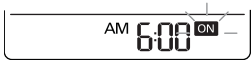
1. Press  on the remote control.
  - The ON icon will flicker to the right of the time display on the display screen.





2. Press the up and down buttons   to scroll and then select the minutes (hours will scroll).
3. Press  when finished to exit the setting mode.

#### Setting an Automatic Off Time

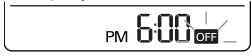





1. Press  on the remote controller.
  - The OFF icon will flicker to the right of the time display on the display screen.



2. Press the up and down buttons   to scroll and then select the minutes (hours will scroll).
3. Press  when finished to exit the setting mode.

#### Setting Sleep Mode

Sleep mode is used to automatically turn off the air conditioner at a set time. It is a "countdown" timer and can be set for up to 7 hours ahead of the current time.

1. Press  to turn on the indoor unit.
  2. Press  to initiate sleep mode settings.
  3. Press the up and down buttons   to select the number of hours.
  4. Press  to exit the setting mode.
-  appears on the display screen to signify the unit has been set to sleep mode.

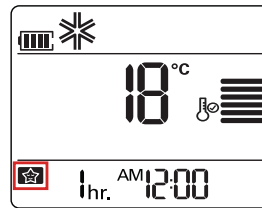

Your display screen might appear slightly different depending on your model.



#### Note:

*In cooling and dehumidifying mode, the temperature increases by 1.8 °F (1 °C) after 30 minutes and by an additional 1.8 °F (1 °C) after another 30 minutes for a more comfortable sleep environment. The temperature increases up to 3.6 °F (2 °C) from the present temperature..*

#### Cancelling Timer Settings

1. Press .
2. Press  a second time to cancel all timer settings.

# ADVANCED FUNCTIONS

## Jet Cool/Jet Heat Operation - Auto Changeover Operation

### Jet Cool/Jet Heat Operation

#### Rapid Cooling and Heating of Room Temperature

This mode allows you to rapidly cool indoor air (during summer months) or warm indoor air (during winter months).

1. Press to turn on the indoor unit.
2. Press the Surge button to initiate surge mode.

#### Note:

- In cool mode the unit operates at a setpoint of 64.4 °F (18 °C) for a duration of 30 minutes.
- In heat mode the unit operates at a setpoint of 86 °F (30 °C) for a duration of 30 minutes.

### Auto Clean Operation

#### Indoor Air Purification

While in cooling and dehumidifying mode, the air conditioner generates moisture on the interior of the indoor unit. The auto clean operation is used to remove this type of moisture.

- Press to start dehumidifying operation.
- is displayed on the remote controller display screen.

#### Note:

- If the power is turned off, the fan will operate for 30 minutes and will clean the inside of the indoor unit.
- Some buttons (functionality) will not operate while the system is in auto cleaning mode.
- This function may not be available on all models.

### °C/°F Screen Display

Single Zone Mega systems can display the temperature in either Celsius (°C) or Fahrenheit (°F).

To adjust the screen display, press and hold for 5 seconds.

### Auto Operation (Cooling Models Only)

During this functionality, the fan speed and the temperature adjust automatically based on the room temperature.

1. Press to turn on the indoor unit.
2. Press repeatedly to select auto operation.
  - will be displayed on the remote control display screen. Refer to Figure 9 for additional information.
3. Press the up and down arrows to select the desired numerical operation code for cooling/heating strength. See the table in Figure 9 for a description of each numerical value.

#### Note:

- During auto operation mode you cannot adjust the fan speed.
- This function may not be available on models.

Figure 9: Auto Operation Screen with Code Descriptions

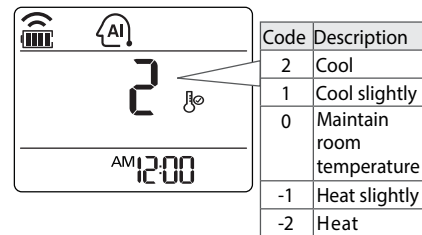

Code	Description
2	Cool
1	Cool slightly
0	Maintain room temperature
-1	Heat slightly
-2	Heat

### Auto Changeover Operation

This function changes the operation mode automatically to maintain a set temperature of  $\pm 3.6$  °F ( $\pm 2$  °C).

1. Press to turn on the indoor unit.
2. Press repeatedly to select auto operation.
  - will be displayed on the remote control display screen.
3. Press the up and down arrows to select the desired temperature. The temperature range is 64.4 °F (18 °C) through 86 °F (30 °C).
4. Press repeatedly as needed to adjust the fan speed.

Figure 10: Auto Changeover Display

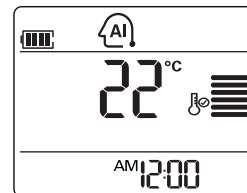

#### Note:





- Your screen display may look slightly different depending on your model.
- This function may not be available on all models.

# ADVANCED FUNCTIONS

## Energy Saving Operation - Auto Restart

### Energy Saving Operation (Cooling)

Placing the unit in energy mode minimizes power consumption during cooling. It increases the set temperature to the optimal level for a more comfortable environment.

1. Press  to turn on the indoor unit.
2. Press  repeatedly until the cooling symbol (snowflake)  is displayed on the remote control display screen.
3. Press  to place unit into energy saving mode.
  -  appears on the display screen.

#### Note:

- During energy saving mode, you could see a different display between the actual indoor unit and the remote controller display screen. This does not mean that the unit is malfunctioning.
- This function may not be available on all models.

### Manual Operation

#### Operating a Unit Without a Remote

If the remote control is unavailable or inoperable (i.e., it needs new batteries), you can use the On/Off button located on the indoor unit to activate the air conditioner.

#### Note:

The fan speed will be automatically set to high when manually operating the air conditioner from the wall unit.

1. Open the front panel of the indoor unit by lifting both sides of the cover slightly as shown in Figure 11.

Figure 11: Lifting the Indoor Unit Panel

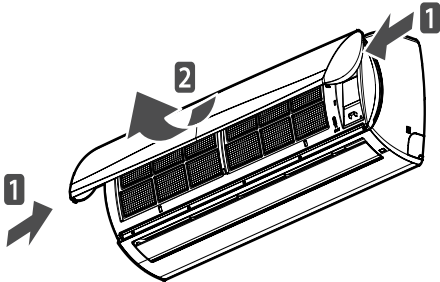

2. Press the On/Off button as shown in Figure 12.

Figure 12: Indoor Unit On/Off Button

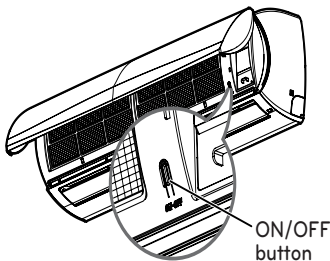

#### Note:

Your indoor unit may appear slightly different depending on the model.

3. Immediately close the front panel after pressing the On/Off button as shown in Figure 13. Use both hands when closing the panel.

Figure 13: Closing the Indoor Unit Front Panel

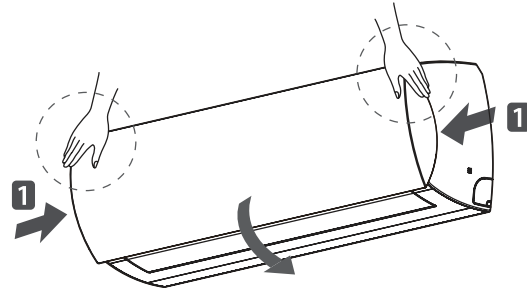

If your system is capable of both heating and cooling, the operation mode will change depending on the room temperature. Refer to Table 5 to determine what the set temperature will be (based on the room temperature).

Table 5: Set Temperature

Room Temperature	Set Temperature	Operation Mode
Below 69.8 °F	75.2 °F	Heating Operation
Above 69.8 °F but below 75.2 °F	73.4 °F	Dehumidifying Operation
Above 75.2 °F	71.6 °F	Cooling Operation

#### Note:

For cooling only models, the temperature will be set at 71.6 °F.

### Auto Restart

After a power failure the unit can be programmed to automatically restart (reboot) and remember the previous settings. This function is a factory default setting, but it can be disabled.

#### Disabling Auto Restart

1. Open the front cover of the indoor unit by lifting up both sides of the cover slightly (use two hands). Refer to Figure 11.
2. Press and hold the On/Off button for 6 seconds. Refer to Figure 12.
  - The indoor unit will beep twice and the light will blink 6 times. Auto restart is now disabled.

#### Enabling Auto Restart

1. To re-enable the auto restart function, press and hold the On/Off button for 6 seconds.
  - The indoor unit will beep twice and the light will blink 4 times. Auto restart is now enabled.

#### Note:

- This function may not be available on all models.
- If you press and hold the On/Off button for 3-5 seconds instead of 6 seconds (in other words, a shorter duration), the unit will be placed in test operation mode. In test operation mode, the unit blows out strong air for cooling, for 18 minutes and then it returns to the factory default settings.



# MAINTENANCE

## Indoor Unit - Cleaning Intervals

Clean the product regularly to maintain optimal performance and to prevent possible breakdown. Refer to Figure 14 for proper filter placement. Refer to Table 6 for detailed instructions on maintenance. Review all safety instructions at the front of this manual, and adhere to all warnings and notes on this page before proceeding with maintenance.

Figure 14: Indoor Unit Filter Location

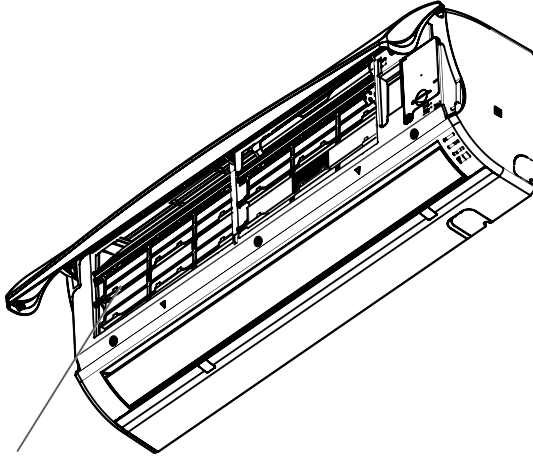

Air filter

### Maintenance Precautions

#### **⚠ WARNING**

Turn off power and unplug the cord before performing any maintenance to avoid electric shock.



- Never use water that is hotter than 104 °F (40 °C) when cleaning filters. It may cause deforming (warping) or discoloration.
- Never use volatile substances when cleaning filters. They may damage the surface of the product.

#### **Note:**

- The location and shape of the filter may vary depending on the model.
- Be sure to clean the heat exchanger coils of the outdoor unit regularly. Dirt collected in the coils may decrease the operational efficiency or increase energy costs.

Table 6: Maintenance and Cleaning Interval Instructions

Item	Cleaning Interval	Cleaning Instructions
Air Filter	Every 2 weeks	Refer to the "Air Filter - Cleaning/Maintenance" section on page 19
Indoor Unit Surface	Regularly	Use a soft dry cloth. Do not use bleach or abrasives.
Outdoor Unit	Regularly	Use steam to clean the heat exchanger coils and the panel vents. If needed, consult with a technician on proper outdoor unit care.

# MAINTENANCE

## Cleaning the Air Filter

### Note:

- Use two hands when lifting the front panel away from the indoor unit.
- Maintain a grip on the front panel at all times while removing filters.

### Air Filter - Cleaning/Maintenance

Clean the indoor unit air filter at least once every 2 weeks or more often if necessary.

1. Turn off the power and unplug the power cord.
2. Open the indoor unit front cover by lifting up both sides of the cover slightly. Refer to Figure 15.

Figure 15: Lifting Indoor Unit Front Panel

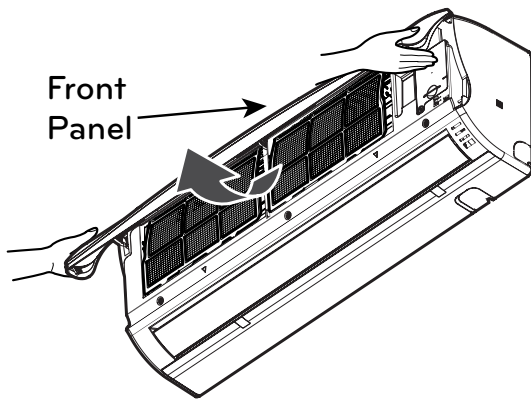

3. Grasp the knob/tab at the bottom of the air filter, lift up slightly and slide it from the indoor unit. Refer to Figure 16.

Figure 16: Removing the Filter

### Filter Removal

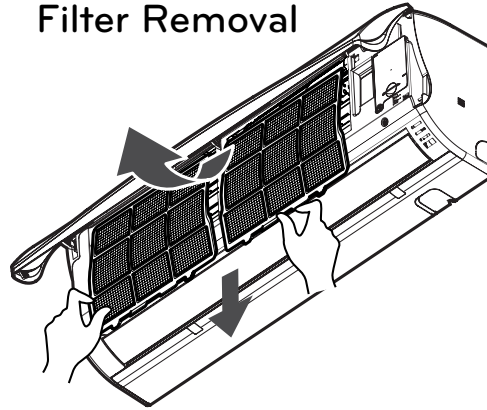

4. Clean the filter with a vacuum cleaner or with warm water. If the dirt is difficult to remove, wash the filter in luke warm water with detergent.
5. Completely dry the filter before placing it back into the unit.
6. Replace the filter by sliding it back into the unit. While grasping the bottom knob/tab, lower the filter back into the unit.
7. Close the front panel of the indoor unit.

## Self-diagnosis Function

Single Zone Mega systems have a built-in self-diagnosis function. If an error occurs, the indoor unit lamp will blink in 2 second intervals. If this occurs, refer to Table 7 for initial troubleshooting steps. If the problem persists, contact your local dealer or service center immediately.

## LG Customer Information

Contact the LG Service Center immediately if you experience issues listed in Table 7.

LG Service Center	
<p>LG Electronics USA 201 James Record Rd SW Huntsville, AL 35824 888-865-3026</p>	<p>For USA calls: Press #2 for Packaged Terminal Air Conditioners (PTAC) or Through the Wall products (TTW) Press #3 for Duct-free Split Systems or Multi V Systems --Call the installing contractor to initiate your product warranty --Call the LG Service Center if service issues have not been addressed by the contractor</p>
<p>LGECI LG Electronics Canada Inc. 20 Norelco Drive North York, Ontario M9L 2X6 Canada 888-LG-CANADA (888-542-2623)</p>	<p>Contact LGECI for all service issues in Canada</p>
<p>www.LG.com</p>	<p>Online product registration</p>

# TROUBLESHOOTING

Table 7: Single Zone Mega Wall Mount System Troubleshooting

Issue	Cause	Corrective Action
There is a burning smell and strange sound coming from the unit.	N/A	Immediately turn off the air conditioner and contact your installing contractor.
Water leaks from the indoor unit even when the humidity level is low.		
The power cord is damaged or generating excessive heat.		
A switch, a circuit breaker (safety, ground) or a fuse is not operating properly.		
The air conditioner does not work.	The air conditioner will not turn on.	Ensure the power cord is plugged into the outlet.
	A fuse has blown or the power supply is blocked.	Replace the fuse or check if the circuit breaker has tripped.
	A power failure has occurred.	Turn off the air conditioner when a power failure occurs. When the power is restored, wait 3 minutes, and then turn on the air conditioner.
	The voltage is too high or too low.	Check if the circuit breaker has tripped.
	The air conditioner turned off automatically at a preset time.	Press the power button.
	Battery setting is wrong on the remote controller.	<ul style="list-style-type: none"> <li>• Check to see that the batteries are inserted with the correct terminals (+) and (-).</li> <li>• Replace with new batteries.</li> </ul>
The air conditioner does not generate cool air.	Air is not circulating properly.	Make sure that no curtains, blinds or furniture are blocking the front of the air conditioner.
	The air filter is dirty.	Clean the air filter once every 2 weeks. Refer to the "Air Filter - Cleaning/Maintenance" section for additional information.
	The room temperature is too high.	In the summer it may take additional time to cool indoor air. In this case, select jet cool operation to cool the indoor air quickly. Refer to "Jet Cool/Jet Heat Operation" for additional information.
	Cold air is escaping from the room.	Ensure cold air is not escaping through ventilation points in the room.
	The desired temperature is higher than the set temperature.	Set the desired temperature to a level lower than the current temperature.
	There is a nearby heating source.	Avoid using a heat generator such as an electric oven or gas burner while the air conditioner is in operation.
	Air circulation operation is selected.	During air circulation operation, air blows from the air conditioner without cooling or heating the indoor air. Switch the operation mode to cooling operation.
	Outside temperature is too high.	Air conditioner cooling capacity may not be sufficient to handle hot weather.

# TROUBLESHOOTING

Table 7: Single Zone Mega Wall Mount System Troubleshooting (Continued)

Issue	Cause	Corrective Action
The air conditioner does not generate warm air.	When heating mode is started.	This is normal operation for the unit. During start-up, the unit is preparing warm air.
	Vane is almost closed and air flow does not come out.	
	Outdoor unit is operating, but no warm air is generating.	<ul style="list-style-type: none"> <li>• In heating mode, ice/frost is built up on the coils when the outside temperature falls.</li> <li>• Defrost mode removes a layer of frost from the coil.</li> <li>• Wait until this operation is completed. It takes approximately 15 minutes.</li> </ul>
	Outdoor unit is in defrost mode at the time.	
	Outdoor temperature is too low.	Heating capacity of the unit may not be sufficient to effectively warm air.
The air conditioner stops during operation.	The air conditioner suddenly turns off.	<ul style="list-style-type: none"> <li>• Check to see if timer function has been set to turn off at a designated time.</li> <li>• Check timer settings and make adjustments as needed.</li> </ul>
	Power failure has occurred during air conditioner operation.	<ul style="list-style-type: none"> <li>• Auto restart is the default setting and the system is rebooting.</li> <li>• If you experience frequent power failures, it is helpful to verify that the system is set to auto restart so the unit can power up quickly.</li> </ul>
Air conditioner is still operating, even after being shut down.	Auto clean mode is in operation. This function removes the rest of the moisture from the indoor unit.	Wait until the auto clean mode has finished and then turn off this feature.
Unable to adjust fan speed.	The auto operation, jet cool or heat or dehumidifying mode is selected.	These modes do not allow you to adjust the fan speed. Change the indoor unit mode in order to adjust the fan speed.
Unable to adjust the temperature.	Air circulation or jet cool/jet heat mode is selected.	These modes do not allow you to adjust the temperature. Change the indoor unit mode in order to adjust the temperature..
Mist discharges from the air outlet of the indoor unit.	Cooled air from the indoor unit can form a mist.	If the room temperature is lowered, the mist will stop forming.
Water leaks from the outdoor unit.	Cooled air from the air conditioner is forming mist.	Install a drain hose under the base pan and contact the installing contractor.

# TROUBLESHOOTING

Table 7: Single Zone Mega Wall Mount System Troubleshooting (Continued)

Issue	Cause	Corrective Action
Unusual noise or vibration during unit operation.	Clicking noise during operation. A clicking sound can be heard either when the unit starts or stops due to movement of the reversing valve.	These are normal noises for the air conditioner as it shifts into different modes of operation. Once a mode is activated, noise or vibration should stop.
	Creaking sound during operation. The plastic parts of the indoor unit make sounds due to shrinkage and expansion during sudden temperature shifts.	
	Water flowing sounds. Switching of the flow of refrigerant through the air conditioner produces water flowing noise.	
Unusual odor emits from indoor unit.	A bad odor can emit from the indoor unit due to mustiness or cigarette odor being taken in by the indoor unit from the room it is located in.	If the smell does not disappear, clean the air filter. If the odor \ persists after cleaning the air filter, contact the installing contractor.

Table 8: Troubleshooting Wired Remote Controllers<sup>1</sup>

Issue	Corrective Action
Directional buttons such as up/down or left/right do not function when selected on wired remote controller.	If the air conditioner function is available (active), then the wired remote controller will be able to change the air conditioner operation mode.
Directional swing buttons do not display when selected on the wired remote controller.	
Unable to select power heating on indoor unit.	
Unable to set power heating on wired remote controller.	Not possible to set time for automatic on/off operation with a wired remote controller or by using app software.
The remaining time for the automatic on/off timer is not shown on the app software.	

<sup>1</sup>Wired remote controllers - PQRCVSL0(QW) or LG Programmable Thermostat - PREMTB10U (only sold in the US)

This page intentionally left blank.

*Inverter*

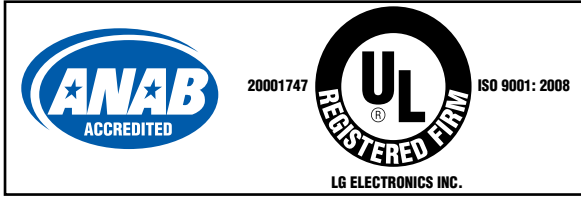

LG Electronics USA, Inc.  
Commercial Air Conditioning Division  
4300 North Point Parkway  
Alpharetta, Georgia 30022  
[www.lghvac.com](http://www.lghvac.com)

LG Electronics Commercial Products Support  
1-888-865-3026 USA  
Follow the prompts for commercial A/C products.