



# DURAFLEX® SS & AL RELINING SYSTEMS

MASONRY CHIMNEY RELINING SYSTEMS FOR APPLIANCES FUELED BY GAS, PELLET, OIL, WOOD, OR COAL.



## DURAFLEX® SS - STAINLESS STEEL

DuraFlex SS is available in 304 and 316Ti stainless steel. The 304 SS and 316Ti SS are designed for use with pellet, non-condensing gas, and oil appliances. DuraFlex 304 SS and 316Ti SS, when used with the Simpson Dura-Vent Two-Ply Insulation Sleeve, may be used for relining wood-burning fireplace inserts and stoves to meet UL 1777 and ULC S635 standards with 0" clearance to masonry.

- DuraFlex SS accessories feature fast connect bands for quick assembly and installation. No screws are required.
- DuraFlex SS Cap attaches securely and quickly to flex lengths with fast connect bands.
- DuraFlex SS Tee attaches quickly to flex lengths or rigid pipe with fast connect bands.
- DuraFlex SS Connector attaches quickly with fast connect bands to make a drip-free connection when connecting two pieces of flex together.

## DURAFLEX® SS CONSTRUCTION

- Single-wall .006" stainless steel flex reliner
- Listed to UL 1777 (file MH14420) and ULC S635
- 304 or 316Ti Stainless steel
- Clearances - 0" to masonry for gas, pellet, and oil applications.
- 1" clearance to masonry (for HT applications, the Two-Ply Insulation Sleeve is required for 0" clearance to masonry.)
- Limited Lifetime Warranty

## DURAFLEX® AL CONSTRUCTION

- Single-wall aluminum flex reliner
- Listed to UL 1777 (file MH14420)
- .010" Aluminum (2-ply of .005")
- Clearances - 0" to masonry
- Limited Lifetime Warranty

DuraFlex SS and DuraFlex AL Relining Systems ensure safe and efficient venting of heating appliances while protecting the masonry chimney from the damaging effects of flue product condensation.

DuraFlex SS and DuraFlex AL are listed and tested by Underwriters Laboratories and carries a Limited Lifetime Warranty.

DuraFlex SS is designed for use with pellet, non-condensing gas, and oil appliances. When used with the Simpson Dura-Vent Two-Ply Insulation Sleeve, it may be used for relining wood-burning fireplace inserts and stoves to meet UL and ULC standards with 0" clearance to masonry.

DuraFlex AL provides an economical means to reline masonry chimney for Category I gas furnaces, water heaters, fireplace inserts, and non-condensing boilers. DuraFlex AL is made of two-ply aluminum.

## DURAFLEX® AL - ALUMINUM

DuraFlex AL, an aluminum relining system, provides an economical means to reline masonry chimney for Category I gas furnaces, water heaters, fireplace inserts, and non-condensing boilers. DuraFlex AL is made of 2-ply .010" aluminum and features a 10-year warranty. DuraFlex AL flexible aluminum liner and components are UL Listed.



## DURAFLEX TOP TERMINATIONS ARE EASY TO INSTALL

- Fast connect bands ensure a tight, secure fit for a leak-proof installation. No screws required.
- The extension on DuraFlex Top Plate eliminates the use of a storm collar in both AL and SS installations.
- The aluminum DuraFlex AL Cap attaches directly to flex pipe as it exits the DuraFlex Top Plate.

The DuraFlex Aluminum and Stainless Steel Liner Kits provide a complete installation in diameter choices of 3" - 8" and lengths of 15', 25' and 35'. DuraFlex aluminum and stainless steel flex is available in 25', 35', and 50' lengths to fit all size jobs.

Limited Lifetime Warranty.

## SAFETY AND EFFICIENCY

DuraFlex SS and DuraFlex AL Relining Systems ensure safe and efficient venting of heating appliances while protecting the masonry chimney from the damaging effects of flue product condensation.

DuraFlex SS and DuraFlex AL are listed and tested by Underwriters Laboratories and carries a Limited Lifetime Warranty.

DuraFlex SS is designed for use with pellet, non-condensing gas, and oil appliances. When used with the Simpson Dura-Vent Two-Ply Insulation Sleeve, it may be used for relining wood-burning fireplace inserts and stoves to meet UL and ULC standards with 0" clearance to masonry.

DuraFlex AL provides an economical means to reline masonry chimney for Category I gas furnaces, water heaters, fireplace inserts, and non-condensing boilers. DuraFlex AL is made of two-ply aluminum.

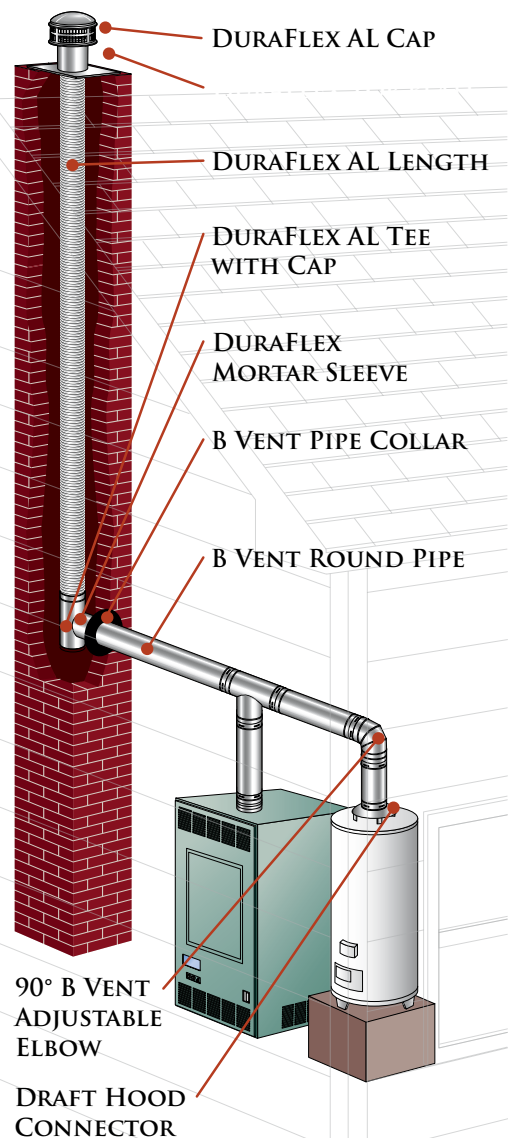
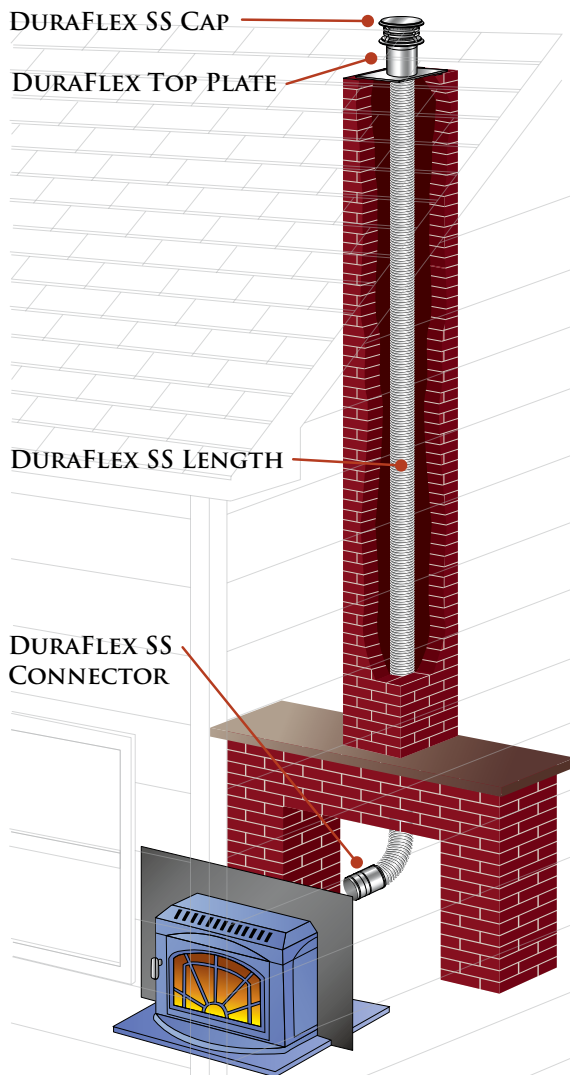

ILLUSTRATION KEY	
1	DuraFlex SS Cap
2	DuraFlex AL Cap
3	DuraFlex Top Plate
4	DuraFlex SS Length
5	DuraFlex AL Length
6	DuraFlex SS Tee
7	DuraFlex AL Tee
8	DuraFlex Mortar Sleeve
9	DuraFlex AL Coupling
10	DuraFlex SS Connector
11	PelletVent Pro Appliance Adapter
12	B Vent Pipe Collar (cat - L201)
13	Rigid Type B Gas Vent (cat - L201)
14	Rigid PelletVent (L Vent)

### Typical Installations

Refer to our Typical Venting Installation drawings to select the appropriate component parts for your installation.

- The inner and outer pipe diameters should match the outlet size of the appliance.

- Check the appliance manufacturer's installation instructions to confirm which types of vent configurations are permitted (i.e. horizontal, vertical, chimney reline, etc.). Also, check for any venting restrictions such as maximum horizontal run, minimum and maximum vertical rise, maximum offset, etc.

- Be fire-safe! Maintain the maximum clearances (air-space) between the vent pipe and nearby combustibles, as specified in the appliance manufacturer's installation instructions. Use proper support and bracing. Follow local building codes and have your venting system inspected.

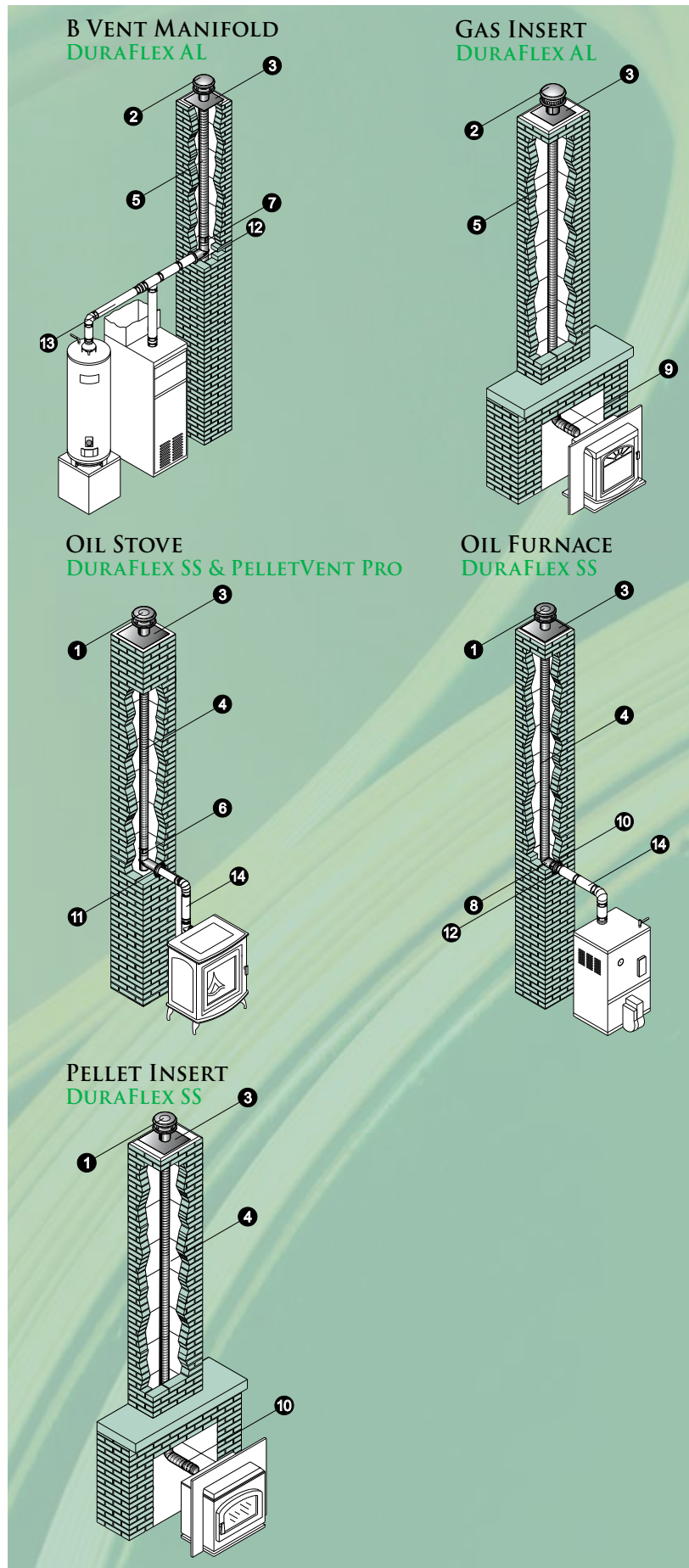

## HOW TO PLAN YOUR VENTING INSTALLATION

Step 1.	Verify the venting requirements of the appliance used. Choose the liner system appropriate for the appliance and installation.
Step 2.	Refer to the Typical Installations for the type of liner installation similar to your situation. Identify the needed parts for installation.
Step 3.	The size of the liner should match the outlet size on the appliance or the size of the vent/manifold that penetrates into the masonry chimney.
Step 4.	Determine the length of liner needed. When using DuraLiner, add 1-½" overlap per joint.
Step 5.	Make sure the top of the masonry chimney has a leveled surface to insure a proper fit for the Top Plate of the reliner and provide a secure, leak-proof installation.
Step 6.	If a free-standing appliance is used, select the vent or stovepipe pieces to connect from the appliance to the liner (refer to the appropriate Simpson Dura-Vent catalog).
Step 7.	For Installations using a Transition Anchor Plate, refer to the DuraTech or DuraPlus catalogs or installation instructions for proper parts and installation.
Step 8	Important! Check to be sure the installation complies with all local and national code requirements, including clearance to combustibles. Contact the local building inspector for permit requirements.

## DURAFLEX STAINLESS STEEL — Stainless steel gas relining

### DURAFLEX SS GAS KIT

Available in 4" - 8" diameters. Kit includes: DuraFlex SS Top Plate and DuraFlex SS Cap. Flex lengths not included.

SIZE	STOCK #
3"	7105-A
4"	7106-A
5"	7100-A
5 1/2"	7101-A
6"	7102-A
7"	7103-A
8"	7104-A



### DURAFLEX SS ALL-FUEL KIT

Available in 4" - 8" diameters. Kit includes: DuraFlex SS Top Plate, DuraFlex SS Cap, and DuraFlex SS Tee. Flex lengths not included.

SIZE	STOCK #
3"	7105-B
4"	7106-B
5"	7100-B
5 1/2"	7101-B
6"	7102-B
7"	7103-B
8"	7104-B

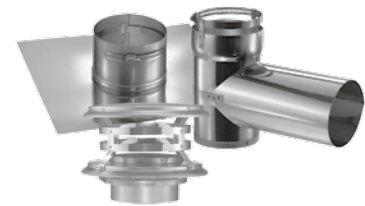

### DURAFLEX SS INSERT KIT

Available in 6" and 8" diameters. Kit includes: DuraFlex SS Top Plate, DuraFlex SS Cap, and DuraFlex SS Flex Connector. Flex lengths not included.

SIZE	STOCK #
6"	7102-D
8"	7104-D



## DURAFLEX SS - STAINLESS STEEL LENGTH

Use with pellet, non-condensing gas, wood-burning, and oil appliances. Available in 3" - 8" diameters. Flex lengths of 15', 20', 25', 30', 35' and 50' available in DuraFlex 304 SS or 316Ti two-ply stainless steel.

SIZE	LENGTH	304	316Ti	SIZE	LENGTH	304	316Ti
3"	15'	7100-15	7020Ti-15	6"	15'	7103-15	7023Ti-15
3"	20'	7100-20	7020Ti-20	6"	20'	7103-20	7023Ti-20
3"	25'	7100-25	7020Ti-25	6"	25'	7103-25	7023Ti-25
3"	30'	7100-30	7020Ti-30	6"	30'	7103-30	7023Ti-30
3"	35'	7100-35	7020Ti-35	6"	35'	7103-35	7023Ti-35
3"	50'	7100-50	7020Ti-50	6"	50'	7103-50	7023Ti-50
4"	15'	7101-15	7021Ti-15	7"	15'	7104-15	7024Ti-15
4"	20'	7101-20	7021Ti-20	7"	20'	7104-20	7024Ti-20
4"	25'	7101-25	7021Ti-25	7"	25'	7104-25	7024Ti-25
4"	30'	7101-30	7021Ti-30	7"	30'	7104-30	7024Ti-30
4"	35'	7101-35	7021Ti-35	7"	35'	7104-35	7024Ti-35
4"	50'	7101-50	7021Ti-50	7"	50'	7104-50	7024Ti-50
5"	15'	7102-15	7022Ti-15	8"	15'	7105-15	7025Ti-15
5"	20'	7102-20	7022Ti-20	8"	20'	7105-20	7025Ti-20
5"	25'	7102-25	7022Ti-25	8"	25'	7105-25	7025Ti-25
5"	30'	7102-30	7022Ti-30	8"	30'	7105-30	7025Ti-30
5"	35'	7102-35	7022Ti-35	8"	35'	7105-35	7025Ti-35
5"	50'	7102-50	7022Ti-50	8"	50'	7105-50	7025Ti-50
5 1/2"	15'	7106-15	7026Ti-15				
5 1/2"	20'	7106-20	7026Ti-20				
5 1/2"	25'	7106-25	7026Ti-25				
5 1/2"	30'	7106-30	7026Ti-30				
5 1/2"	35'	7106-35	7026Ti-35				
5 1/2"	50'	7106-50	7026Ti-50				



## DURAFLEX SS CONNECTOR

Joins DuraFlex SS length to appliance, rigid lengths, or flex lengths with a drip-free connection. Utilizes fast connect band to fit pieces securely.

SIZE	STOCK #	A	B	C
3"	7120	4 1/8"	3 1/2"	3"
4"	7121	4 1/8"	4 1/2"	4"
5"	7115	4 1/8"	5 1/2"	5"
5 1/2"	7116	4 1/8"	5 1/2"	6"
6"	7117	4 1/8"	6"	6 1/2"
7"	7118	4 1/8"	7 1/2"	7"
8"	7119	4 1/8"	8 1/2"	8"

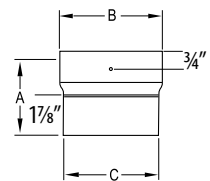

## DURAFLEX SS TEE

Attaches to DuraFlex SS length with a fast connect band. Removable branch connects tee body with an outside fast connect band. Includes Tee Cap.

SIZE	STOCK #	A	B
3"	7180	2 1/2"	8"
4"	7181	2"	8"
5"	7182	2 1/2"	10"
5 1/2"	7186	2 1/2"	10"
6"	7183	2"	10"
7"	7184	2 1/2"	12"
8"	7185	2"	12"

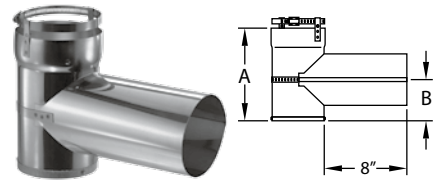

## DURAFLEX SPACER

Use to maintain a 1" clearance with DuraLiner and DuraFlex SS.

SIZE	STOCK #
5"	4568
6"	4668
7"	4768
8"	4868

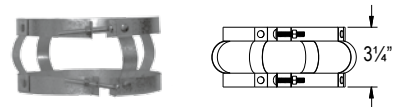

## DURAFLEX SS TOP PLATE

Pull flex length through the DuraFlex Top Plate and attach DuraFlex SS Cap with fast connect band for a secure leak-proof fit. Built-in extension eliminates the use of a Storm Collar

SIZE	STOCK #	A	B
3"	7108	4"	16"
4"	7109	5"	16"
5"	7110	6"	16"
5 1/2"	7111	7"	16"
6"	7112	7"	16"
7"	7113	8"	16"
8"	7114	9"	16"

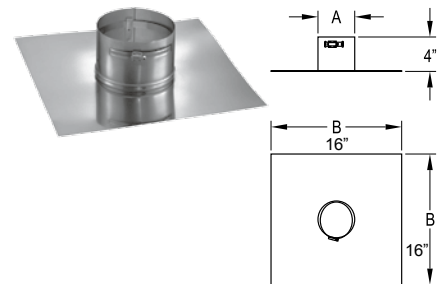

## DURAFLEX SS CAP

Use with 304 & 316Ti SS lengths. Designed to fasten to DuraFlex SS length with fast connect band. 5", 6", 7" and 8" diameters include spark arrestor.

SIZE	STOCK #	A	B
3"	7130	8"	5"
4"	7131	8"	5"
5"	7132	11"	6"
5 1/2"	7136	--	--
6"	7133	11"	6"
7"	7134	15"	6"
8"	7135	15"	6"

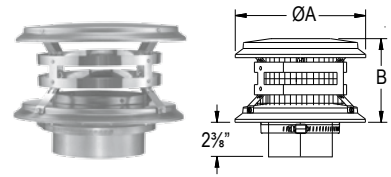

## DURAFLEX ALUMINUM — Aluminum gas relining

### DURAFLEX AL KIT

Available in 3"-8" diameters and in 15', 25', and 35' lengths. Kit includes DuraFlex AL Lengths, DuraFlex AL Cap, DuraFlex Top Plate, and DuraFlex Mortar Sleeve.

SIZE	LENGTH	STOCK #	SIZE	LENGTH	STOCK #
3"	15'	2200	6"	15'	2203
3"	25'	2210	6"	25'	2213
3"	35'	2220	6"	35'	2223
4"	15'	2201	7"	15'	2204
4"	25'	2211	7"	25'	2214
4"	35'	2221	7"	35'	2224
5"	15'	2202	8"	15'	2205
5"	25'	2212	8"	25'	2215
5"	35'	2222	8"	35'	2225

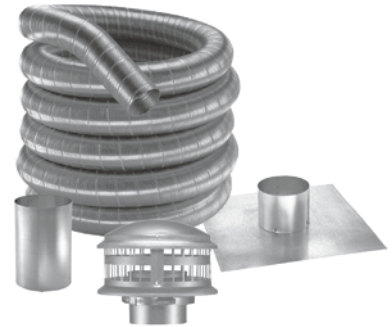



## DURAFLEX AL - ALUMINUM LENGTH

Available in 3" - 8" diameters of 25', 35' and 50' lengths.

SIZE	LENGTH	STOCK #
3"	25'	2270
3"	35'	2280
3"	50'	2290
4"	25'	2271
4"	35'	2281
4"	50'	2291
5"	25'	2272
5"	35'	2282
5"	50'	2292
6"	25'	2273
6"	35'	2283
6"	50'	2293
7"	25'	2274
7"	35'	2284
7"	50'	2294
8"	25'	2275
8"	35'	2285
8"	50'	2295



## DURAFLEX AL COUPLING

Joins DuraFlex AL lengths to appliance, rigid lengths, or flex lengths. To transition to Simpson Dura-Vent Type B Gas Vent, refer to Gas Vent Catalog.

SIZE	STOCK #
3"	2150
4"	2151
5"	2152
6"	2153
7"	2154
8"	2155

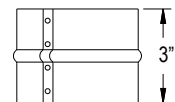

## DURAFLEX AL TEE

Attaches to flex pipe with a fast connect band. Removable branch connects to the tee body with an outside fast connect band. Includes Tee Cap.

SIZE	STOCK #	A	B
3"	2240	2 1/2"	8"
4"	2241	2"	8"
5"	2242	2 1/2"	10"
6"	2243	2"	10"
7"	2244	2 1/2"	12"
8"	2245	2"	12"

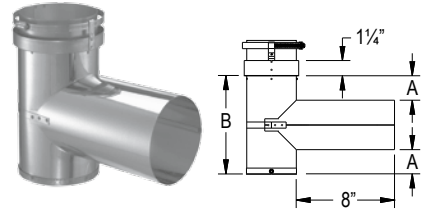

## DURAFLEX AL TOP PLATE

Pull flex length through the DuraFlex Top Plate and attach DuraFlex SS Cap with fast connect band for a secure leak-proof fit. Built-in extension eliminates the use of a Storm Collar

SIZE	STOCK #	A
3"	2100	4"
4"	2101	5"
5"	2102	6"
6"	2103	7"
7"	2104	8"
8"	2105	9"

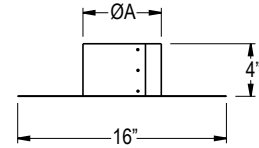
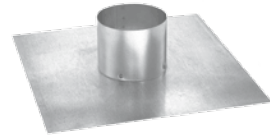

## DURAFLEX AL CAP

Designed to fasten to flex length with fast connect band. No screws required.

SIZE	STOCK #	A	B
3"	2230	8"	7 1/2"
4"	2231	8"	7 1/2"
5"	2232	11"	9"
6"	2233	11"	9"
7"	2234	15"	9 5/8"
8"	2235	15"	9 5/8"

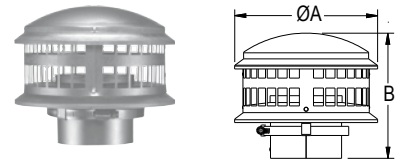

## FEMALE FLEX ADAPTER

Use to connect Simpson Dura-Vent Type B gas vent products to DuraFlex AL

SIZE	STOCK #
3"	2120
4"	2121
5"	2122
6"	2123
7"	2124
8"	2125

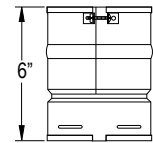

## DURAFLEX ACCESSORIES — For use with both DuraFlex SS and DuraFlex AL

### DURAFLEX MORTAR SLEEVE

Use when passing DuraFlex SS length through a masonry wall.

SIZE	STOCK #	A
3"	2140	4"
4"	2141	5"
5"	2142	6"
6"	2143	7"
7"	2144	8"
8"	2145	9"

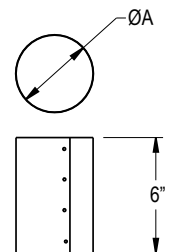

### DURAFLEX FLEX PULLER

Guides DuraFlex lengths down masonry chimney.

SIZE	STOCK #
3"	2190
4"	2191
5"	2192
6"	2193
7"	2194
8"	2195

